



mega[®] 25



PSQ
esquadrias
de alumínio





Tudo foi pensado!

Um conceito de Sistema Construtivo que supera em muito os modelos mais comuns. O Sistema Mega é uma solução completa, com uma incrível combinação para definir modelos e tipologias capaz de atender todos os níveis de obras. O aspecto de inovação está presente nos detalhes e a sofisticação é visível no design. Não há nada igual...

Desde a concepção do desenho dos perfis, até a metodologia para o corte e a montagem foram cuidadosamente planejados para garantir que o Fabricante de Esquadrias ganhe mais tempo e produtividade.

O esquema de montagem é simples e facilita as operações durante o processo de industrialização.



A Linha Mega 25 acompanha o tradicionalíssimo e consagrado padrão 25mm para atender fechamentos de vãos dos mais diferentes níveis e exigências da arquitetura brasileira.



As linhas esbeltas com entornos levemente arredondados incorporam ao conceito do Sistema Mega um toque de classe e elegância que combina ousadia com a indispensável praticidade para se compor tipologias, resultando assim uma melhor performance das peças.



POLÍTICA DE QUALIDADE

Trabalhar com QUALIDADE, unindo forças com a participação de todos e superando sempre as expectativas dos clientes.

A ASA ALUMÍNIO se reserva ao direito de efetuar, a qualquer momento e sem prévio aviso, todas as modificações que julgar necessárias.

As dimensões, espessuras e pesos dos perfis indicados neste catálogo são teóricos, podendo variar em função de tolerâncias previstas nas normas ABNT.

O conteúdo deste catálogo é de propriedade da ASA ALUMÍNIO, e não pode ser copiado em parte ou na sua totalidade sem prévia aprovação.

1	Apresentação	04
2	Tipologias	05
3	Perfis	09
4	Acessórios	57
5	Gráficos	75
6	Normas	83

O Sistema MEGA é composto por três Linhas personificadas que atendem todos os níveis de exigência.

Conseqüentemente, são três bitolas distintas, com a propriedade de se comunicarem entre si, permitindo, assim, obter-se a mais ampla gama de tipologias.

Essa notória versatilidade de composição é uma inovação exclusiva desta família, composta por:



A Linha Mega 25 acompanha o tradicionalíssimo e consagrado padrão 25 mm para atender fechamentos de vãos dos mais diferentes níveis de exigências da arquitetura brasileira.



TIPOLOGIAS

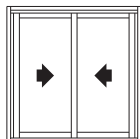

JANELA DE CORRER
2 FOLHAS

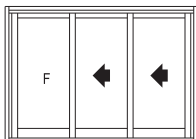

JANELA DE CORRER
3 FOLHAS

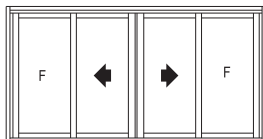

JANELA DE CORRER
4 FOLHAS

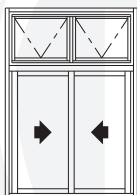

JANELA DE CORRER
2 FOLHAS
COM BANDEIRA MÓVEL

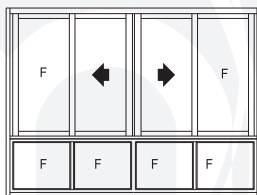

JANELA DE CORRER
4 FOLHAS
COM PEITORIL FIXO

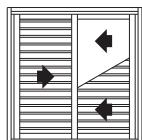

JANELA DE CORRER
3 FOLHAS
COM VENEZIANA

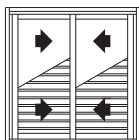

JANELA DE CORRER
4 FOLHAS
COM VENEZIANA

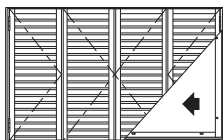

JANELA CAMARÃO

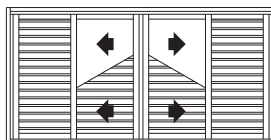

JANELA DE CORRER
6 FOLHAS
COM VENEZIANA

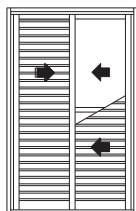

PORTA DE CORRER
3 FOLHAS
COM VENEZIANA

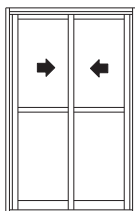

PORTA DE CORRER
2 FOLHAS

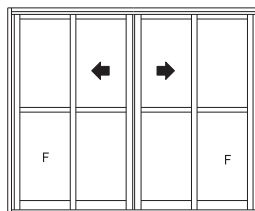

PORTA DE CORRER
4 FOLHAS

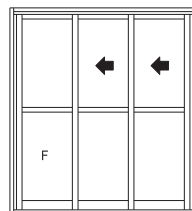

PORTA DE CORRER
3 FOLHAS

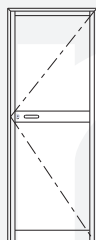

PORTA DE GIRO
1 FOLHA

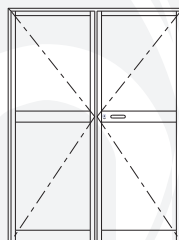

PORTA DE GIRO
2 FOLHAS

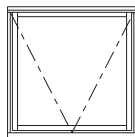

JANELA MAXIM-AR
1 FOLHA

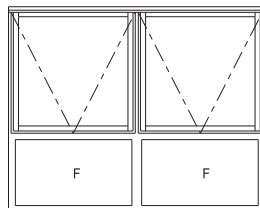

JANELA MAXIM-AR
2 FOLHAS





Índice de perfis

código	descrição	pág	código	descrição	pág	código	descrição	pág
AF-018	Baguete	30	MG25-103	Baguete para fixo	30	MG25-791	Marco lateral correr 02 planos	18
CA-006	Macho de conexão	16	MG25-121	Trilho superior de correr 04 planos	24	MG25-792	Marco lateral de correr 03 planos	23
CA-011	Cunha de conexão	16	MG25-122	Trilho inferior de correr 04 planos	24	MG25-793	Marco lateral de correr 03 planos	23
CA-028	Contramarco	14	MG25-123	Montante lateral de correr 4 planos	24	MG25-794	Pingadeira do marco do maxim-ar	42
CA-032	Contramarco	13	MG25-1230	Baguete	30	MG25-795	Pingadeira da folha do maxim-ar	42
CA-060	Contramarco	12	MG25-186	Travessa da folha	32	MG32-032	Tubeo octogonal de 60 mm	38
CA-063	Contramarco	12	MG25-187	Travessa da folha para palheta	30	MG32-046	Lamina contra-peso de 48 mm	38
CA-096	Contramarco	13	MG25-188	Travessa intermediária da folha	32	MG32-062	Lamina contra-peso de 39,2 mm	38
CA-098	Contramarco	12	MG25-200	Montante com escova maxim-ar	41	MG32-063	Tubeo octogonal de 40 mm	38
CA-113	Contramarco	13	MG25-225	Montante inferior da porta	29	MG32-109	Tampa externa janela integrada	37
CA-129	Contramarco	12	MG25-227	Travessa intermediária da folha	29	MG32-110	Tampa interna janela integrada	37
CA-168	Contramarco	15	MG25-228	Trilho inf. correr porta 02 planos	20	RA-013	Remate	17
CA-204	Contramarco	12	MG25-230	Trilho inf. correr porta 03 planos	21	RA-1009	Remate	17
CA-207	Chumbador para CM-063	16	MG25-266	Travessa inferior da folha	32	RA-1175	Remate	17
CA-209	Chumbador para CM-060	16	MG25-272	Trilho inf. porta correr 02 planos	20	RA-347	Remate	17
CA-517	Contramarco	14	MG25-292	Reversor de Maxim-ar	42	RA-516	Remate	17
CA-709	Contramarco	14	MG25-500	Montante da folha com baguete	28	RA-613	Remate	17
CA-721	Contramarco	12	MG25-501	Montante central interno da folha	28	VA-012	Palheta veneziana 12 mm	39
MG25-001	Trilho superior de correr 02 planos	18	MG25-502	Montante central externo da folha	28	VA-012F	Palheta veneziana 12 mm usinada	39
MG25-002	Trilho inferior de correr 02 planos	18	MG25-503	Montante central intern. da folha	28	VA-017	Palheta veneziana 17 mm	39
MG25-003	Marco lateral correr 02 planos	19	MG25-504	Mont. bi-tubular central interno	28	VA-017F	Palheta veneziana 17 mm usinada	39
MG25-004	Marco superior e inferior	19	MG25-505	Mont. bi-tubular central externo	28	VA-024	Palheta veneziana 9,7 mm	40
MG25-005	Trilho intermediário superior	19	MG25-506	Mata junta central da folha	23	VA-024F	Palheta veneziana 9,7 mm usinada	40
MG25-007	Marco lateral liso correr 2 planos	18	MG25-507	Mata junta	23	CA-093	Grapa	15
MG25-009	Coluna	26	MG25-508	Marco superior integrada	33			
MG25-010	Trilho sup. correr janela 03 planos	21	MG25-509	Marco intermediário integrada	33			
MG25-011	Trilho inf. correr janela 03 planos	21	MG25-510	Trilho inferior integrada	33	Novos Perfis		
MG25-012	Marco lat. liso de correr 03 planos	22	MG25-511	Marco lateral integrada	34	MG25-006	Trilho interm. correr 3 planos	43
MG25-026	Trilho superior correr 2 planos	25	MG25-513	Complemento lateral persiana	34	MG25-008	Mata Junta	44
MG25-027	Trilho inferior correr 2 planos	25	MG25-514	Complemento lateral persiana	34	MG25-013	Marco lateral de correr 3 planos	43
MG25-028	Marco lateral correr 2 planos	26	MG25-515	Tampa interna janela integrada	35	MG25-014	Marco lateral de correr 3 planos	43
MG25-029	Marco superior e inferior	26	MG25-516	Tampa externa janela integrada	35	MG25-015	Trilho superior de correr 2 planos	44
MG25-030	Marco perimetral maxim-ar	41	MG25-517	Tampa interna porta integrada	36	MG25-016	Trilho superior de correr 2 planos	44
MG25-031	Trilho superior correr 3 planos	27	MG25-518	Tampa externa porta integrada	36	MG25-039	Montante da folha com baguete	45
MG25-032	Trilho inferior correr 3 planos	27	MG25-519	Coluna telescópica p/marco lateral	22	MG25-040	Montante central interno da folha	45
MG25-033	Marco lateral correr 3 planos	27	MG25-520	Trilho interm. correr 03 planos	22	MG25-041	Montante central externo da folha	45
MG25-044	Montante lateral/central da folha	29	MG25-578	Trilho inf. correr porta 02 planos	20	MG25-042	Montante central intern. da folha	45
MG25-050	Travessa intermediária da folha	29	MG25-783	Montante da folha sem baguete	31	MG25-043	Montante bi-tubular central folha	46
MG25-053	Travessa da folha	29	MG25-784	Montante da folha veneziana	30	MG25-047	Montante bi-tubular central int.	45
MG25-079	Marco perimetral maxim-ar	41	MG25-785	Montante central veneziana	31	MG25-048	Montante bi-tubular central int.	46
MG25-080	Travessa inferior maxim-ar 45°	41	MG25-786	Montante intermediário veneziana	31	MG25-049	Montante bi-tubular central ext.	45
MG25-081	Montante sem escova maxim-ar	41	MG25-787	Montante central sem baguete	31	MG25-055	Montante da folha sem baguete	46
MG25-082	Travessa inferior maxim-ar 90°	41	MG25-788	Montante central int. sem baguete	31	MG25-056	Montante central int. sem baguete	46
MG25-085	Travessa vertical s/ othal maxim-ar	42	MG25-789	Mont. central c/reforço s/baguete	31	MG25-057	Montante central intern. s/ baguete	46
MG25-086	Travessa vertical c/ othal maxim-ar	42	MG25-790	Travessa intermediária da folha	32	MG25-068	Montante da folha veneziana	46

código	descrição	pág
MG25-069	Montante cent. interm. veneziana	47
MG25-070	Montante central ext. veneziana	47
MG25-083	Pingadeira do marco do maxim-ar	49
MG25-084	Pingadeira da folha do maxim-ar	49
MG25-093	Marco perimétrico basculante	50
MG25-094	Travessa para basculante	50
MG25-097	Montante bscula	50
MG25-098	Montante bscula	50
MG25-099	Montante do fixo	50
MG25-107	Vedao da folha	47
MG25-111	Montante da folha com bguete	47
MG25-192	Montante central da folha	47
MG25-242	Montante central externo da folha	47
MG25-243	Montante central interno da folha	48
MG25-244	Montante central da folha	48
MG25-245	Montante da folha com bguete	48
MG25-246	Montante inferior da folha	48
MG25-289	Montante bi-tubular central int.	48
MG25-290	Montante bi-tubular central ext.	48
MG25-360	Tampa externa integrada	51
MG25-370	Marco superior integrada	52
MG25-380	Tampa interna integrada	52
MG25-390	Trilho inferior integrada	52
MG25-400	Marco lateral integrada	53
MG25-420	Complemento lateral integrada	53
MG25-430	Trilho superior integrada	53
MG25-450	Tampa interna integrada	54
MG25-690	Tampa interna integrada	54
MG25-710	Tampa externa integrada	51
MG25-782	Marco perimtico	55
MG25-787	Montante central sem bguete	49
MG25-796	Montante lateral / central da folha	49
MG25-797	Bguete inferior para veneziana	55
MG25-798	Batedeira porta de giro	55
MG25-799	Montante superior porta de giro	55
MG25-800	Montante inferior veneziana	55
MG25-801	Batente porta de giro	55
VA-201	Palheta veneziana 10mm	49
VA-201F	Palheta veneziana 10mm usinada	49

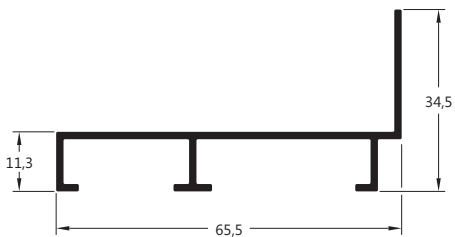

CA-129

0,493 Kg/m

Contramarco

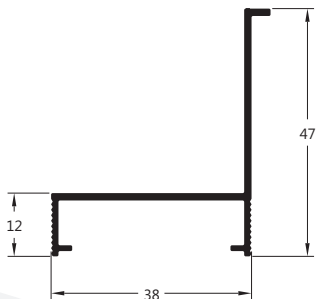

CA-098

0,377 Kg/m

Contramarco

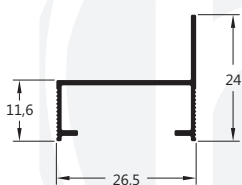

CA-063

0,175 Kg/m

Contramarco

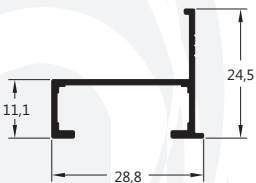

CA-721

0,261 Kg/m

Contramarco

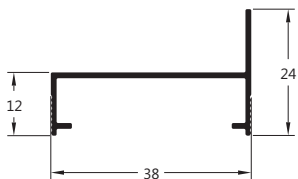

CA-060

0,223 Kg/m

Contramarco

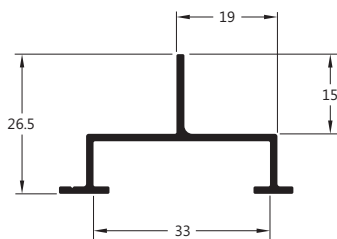

CA-204

0,327 Kg/m

Contramarco

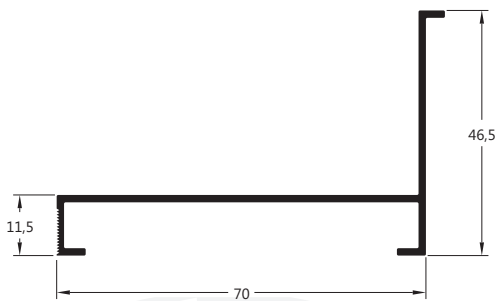

CA-032

0,513 Kg/m

Contramarco

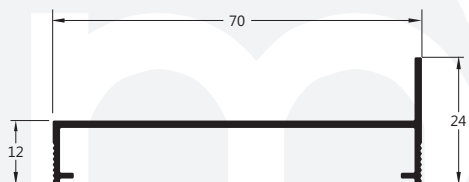

CA-096

0,327 Kg/m

Contramarco

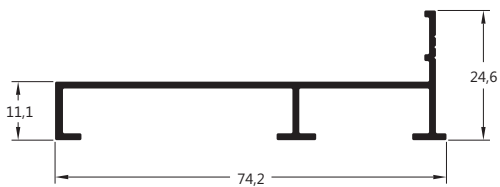

CA-113

0,468 Kg/m

Contramarco

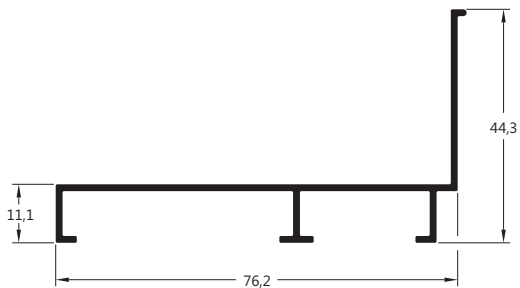

CA-517

0,531 Kg/m

Contramarco

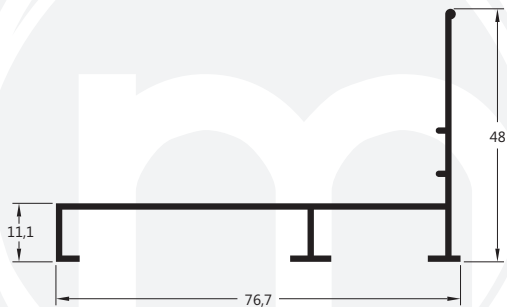

CA-709

0,520 Kg/m

Contramarco

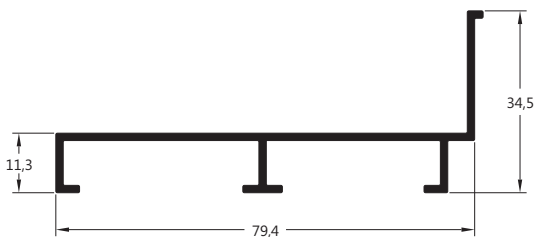

CA-028

0,554 Kg/m

Contramarco

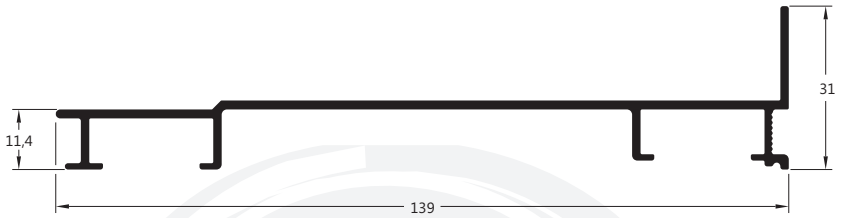

CA-168

0,951 Kg/m

Contramarco



CA-093

0,766 Kg/m

Grapa

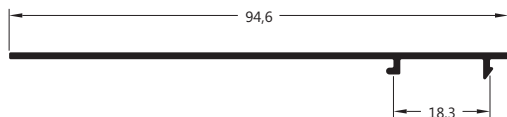

CA-207

0,361 Kg/m

Chumbador para cm-063

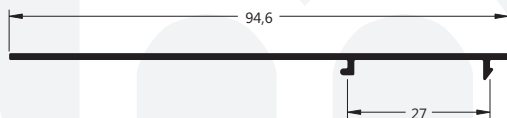

CA-209

0,223 Kg/m

Chumbador para cm-060

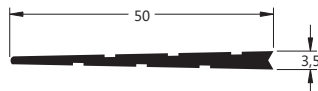
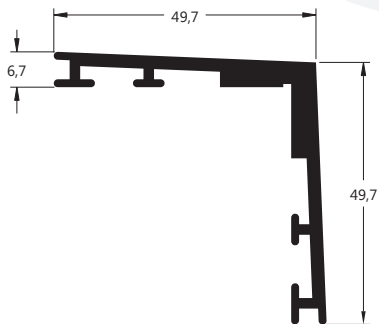

CA-006

1,006 Kg/m

Macho de conexão

CA-011

0,315 Kg/m

Cunha de conexão

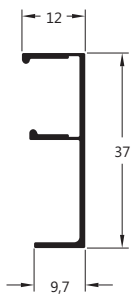

RA-347 0,197 Kg/m Remate

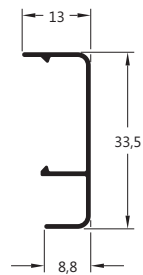

RA-613 0,162 Kg/m Remate

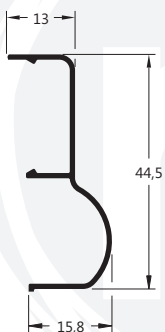

RA-1009 0,209 Kg/m Remate



RA-1175 0,297 Kg/m Remate

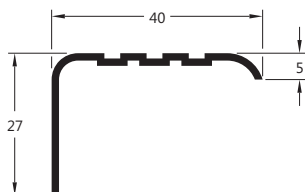

RA-013 0,268 Kg/m Remate

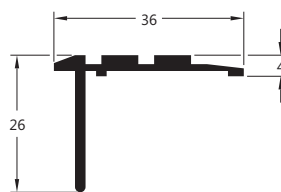

RA-516 0,339 Kg/m Remate

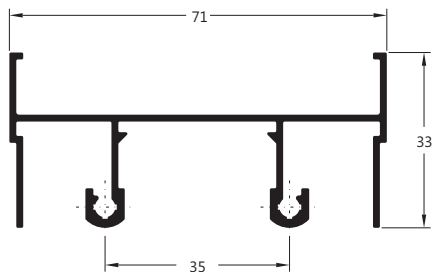

MG25-001 0,773 Kg/m Trilho superior de correr 02 planos

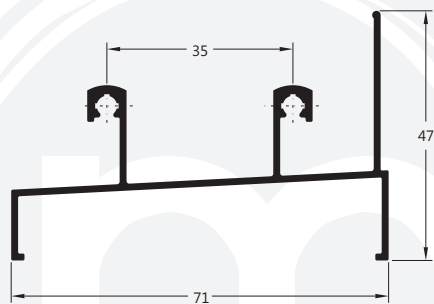

MG25-002 0,711 Kg/m Trilho inferior de correr 02 planos

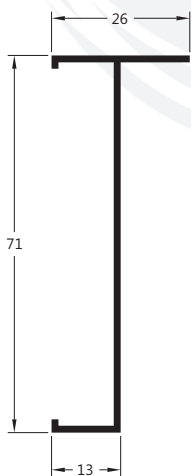

MG25-007 0,386 Kg/m Marco lateral liso de correr 2 planos

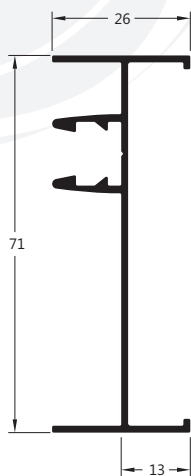

MG25-791 0,561 Kg/m Marco lateral correr 02 planos

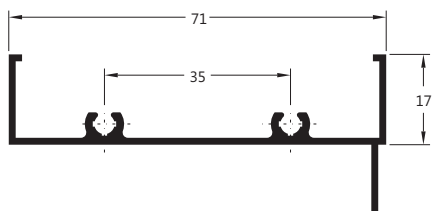

MG25-004

0,526 Kg/m

Marco superior e inferior

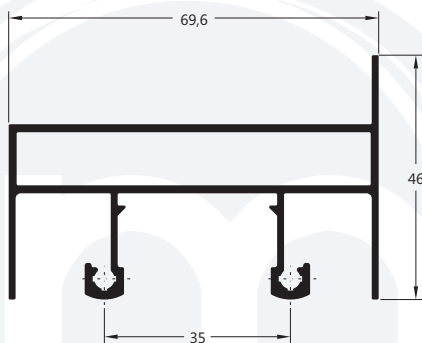

MG25-005

1,106 kg/m

Trilho intermediário superior

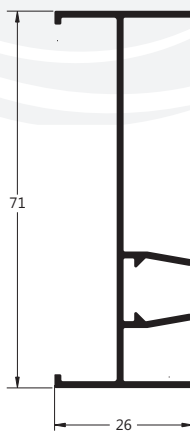

MG25-003

0,537 kg/m

Marco lateral de correr 02 planos
com contra fecho

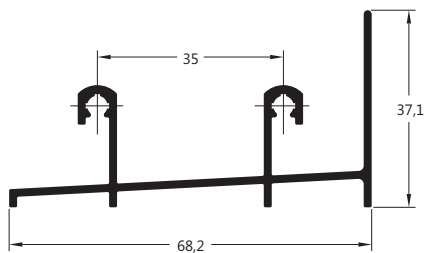

MG25-228	0,791 Kg/m	Trilho inferior correr porta 02 planos
----------	------------	--

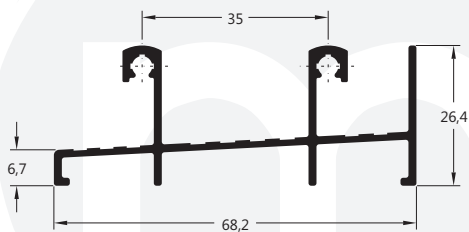

MG25-578	0,707 Kg/m	Trilho inferior correr porta 02 planos
----------	------------	--

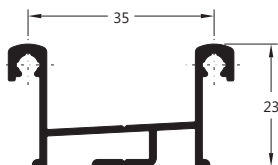

MG25-272	0,430 Kg/m	Trilho inferior porta correr 2 planos
----------	------------	---------------------------------------

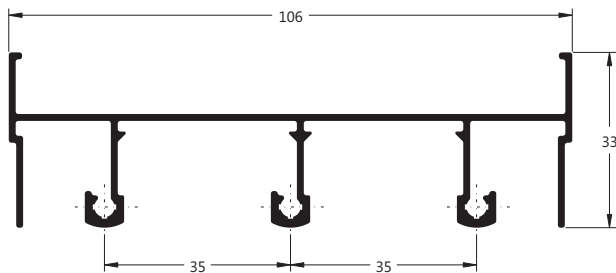

MG25-010

1,028 Kg/m

Trilho superior correr
janela 03 planos

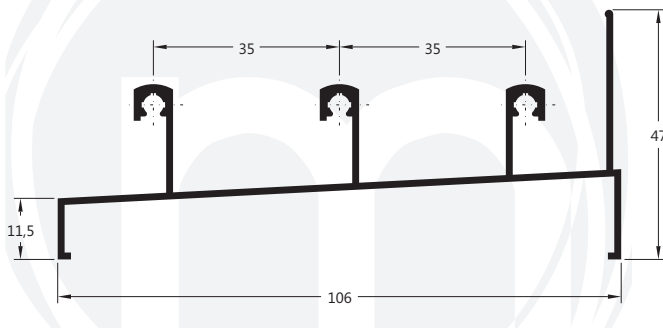

MG25-011

0,960 Kg/m

Trilho inferior correr
janela 03 planos

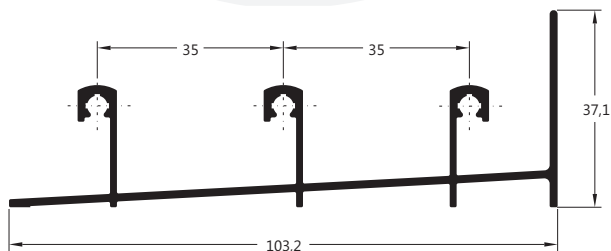

MG25-230

0,976 Kg/m

Trilho inferior correr
porta 03 planos

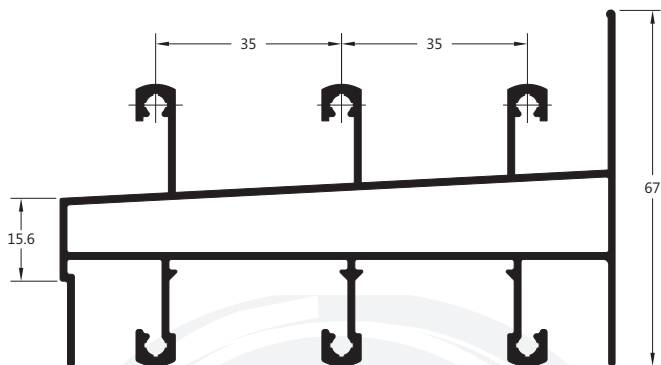

MG25-520

1,856 Kg/m

Trilho intermediário
correr 03 planos

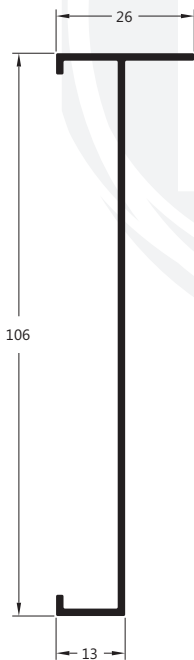

MG25-012

0,559 Kg/m

Marco lateral liso
de correr 03 planos

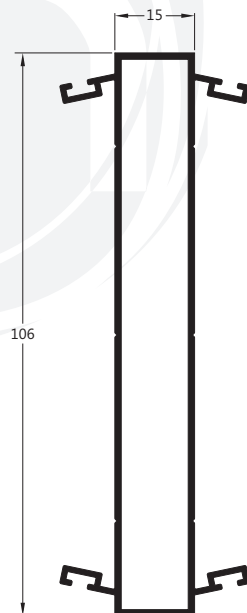

MG25-519

0,963 Kg/m

Coluna telescópica
para marco lateral

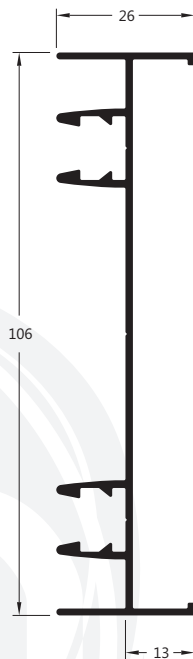
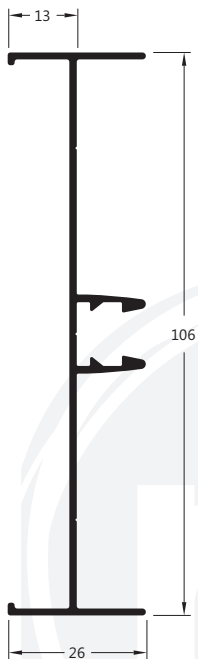

MG25-792 0,710 Kg/m Marco lateral de correr 03 planos

MG25-793 0,840 Kg/m Marco lateral de correr 03 planos



MG25-507 0,383 Kg/m Mata junta

MG25-506 0,303 Kg/m Mata junta central da folha

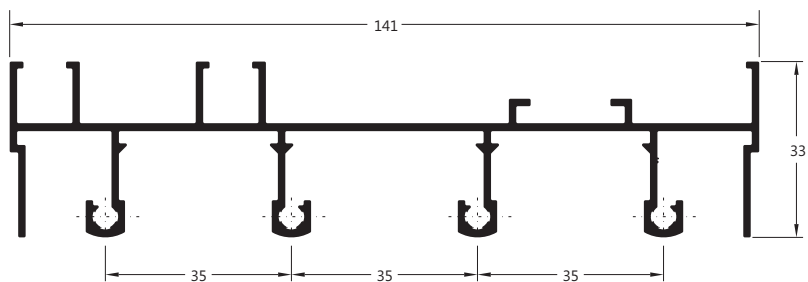

MG25-121 1,585 kg/m Trilho superior de correr 04 planos

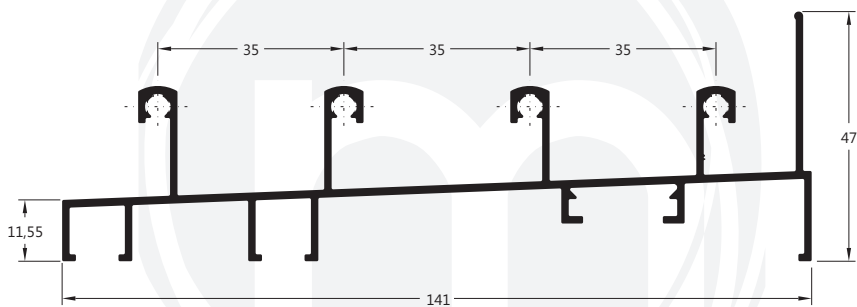

MG25-122 1,509 Kg/m Trilho inferior de correr 04 planos

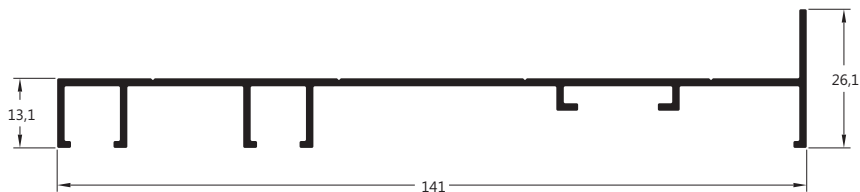

MG25-123 0,917 Kg/m Montante lateral de correr 4 planos

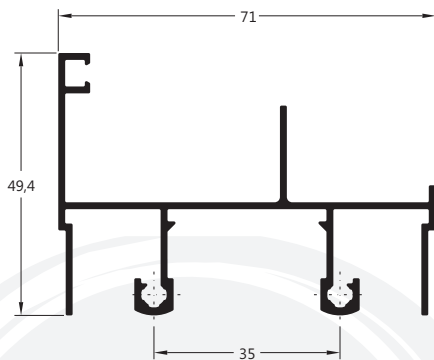

MG25-026

0,855 Kg/m

Trilho superior correr 2 planos

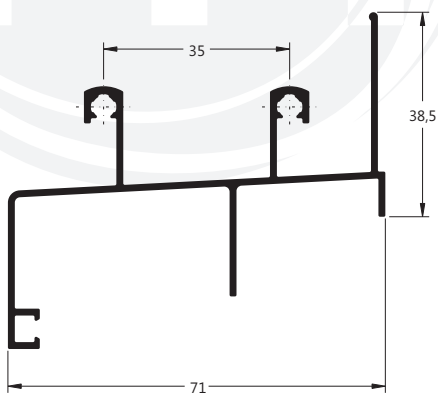

MG25-027

0,803 kg/m

Trilho inferior correr 2 planos

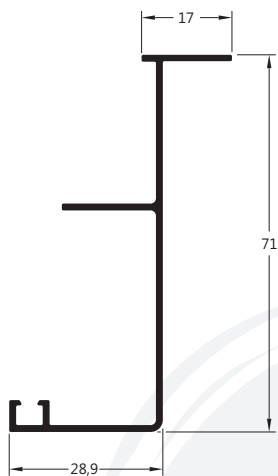

MG25-028

0,487 Kg/m

Marco lateral correr 2 planos

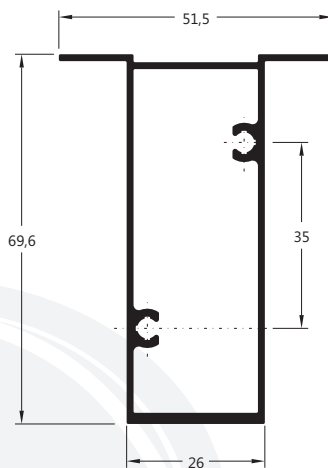

MG25-009

0,907 Kg/m

Coluna

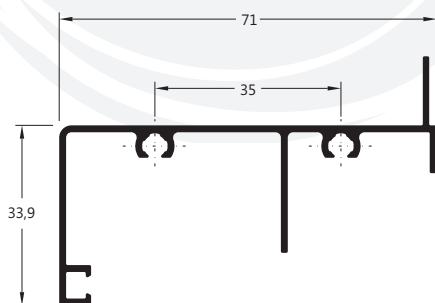

MG25-029

0,630 Kg/m

Marco superior e inferior

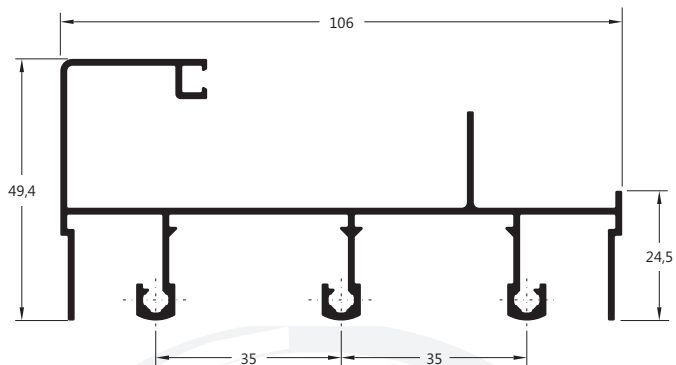

MG25-031 1,200 Kg/m Trilho superior correr 3 planos

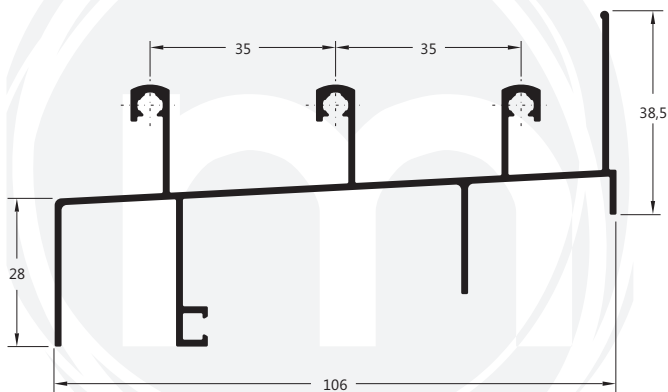

MG25-032 1,137 Kg/m Trilho inferior correr 3 planos

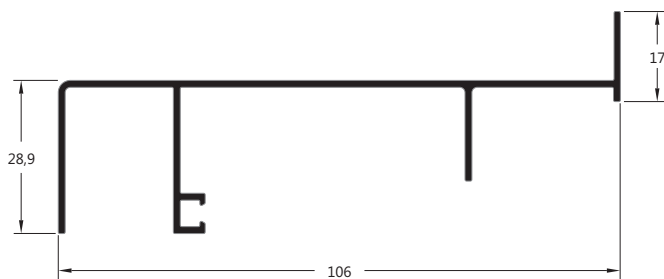

MG25-033 0,703 Kg/m Marco lateral correr 3 planos

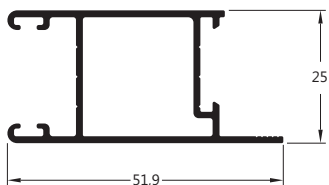

MG25-500

0,542 Kg/m

Montante da folha
com bagueete

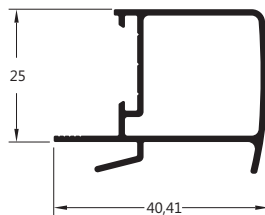

MG25-501

0,458 Kg/m

Montante central
interno da folha

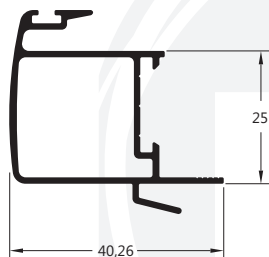

MG25-503

0,523 Kg/m

Montante central
intermediário da folha

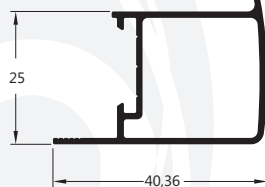

MG25-502

0,490 Kg/m

Montante central
externo da folha

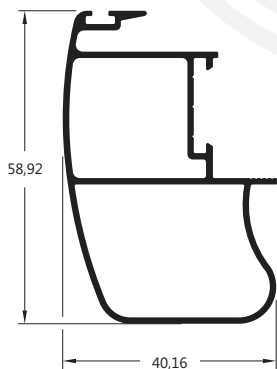

MG25-505

0,745 Kg/m

Montante bi-tubular
central externo

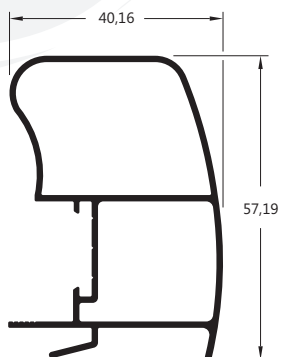

MG25-504

0,757 Kg/m

Montante bi-tubular
central interno

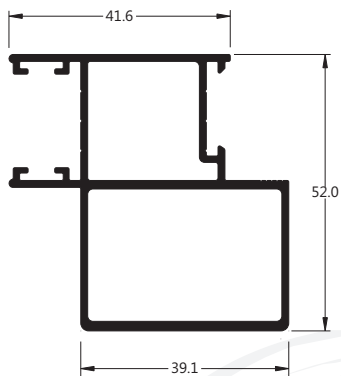

* Ver perfil MG25-796

MG25-044	0,997 Kg/m	Montante lateral / central da folha
----------	------------	-------------------------------------

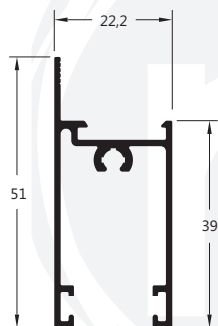

MG25-053	0,542 Kg/m	Travessa da folha
----------	------------	-------------------

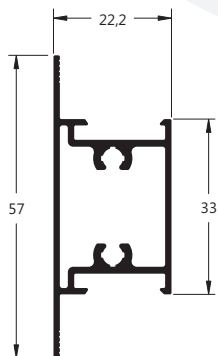

MG25-227	0,574 Kg/m	Travessa intermediária da folha
----------	------------	---------------------------------

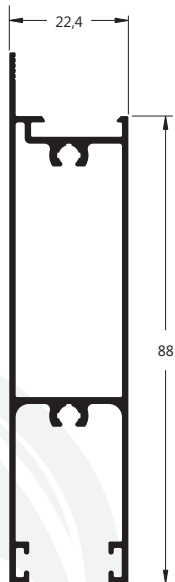

MG25-225	0,926 Kg/m	Montante inferior da porta
----------	------------	----------------------------

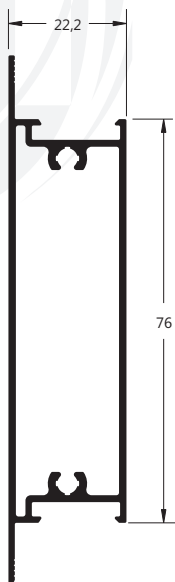

MG25-050	0,926 Kg/m	Travessa intermediária da folha
----------	------------	---------------------------------

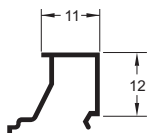

MG25-1230	0,110 Kg/m	Baguete
-----------	------------	---------

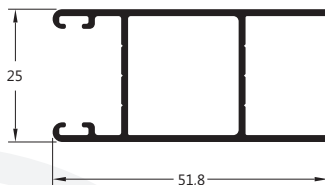

MG25-784	0,555 Kg/m	Montante da folha veneziana
----------	------------	-----------------------------

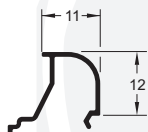

AF-018	0,104 Kg/m	Baguete
--------	------------	---------

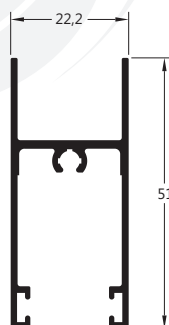

MG25-103	0,156 Kg/m	Baguete para fixo
----------	------------	-------------------

MG25-187	0,534 Kg/m	Travessa da folha para palheta
----------	------------	--------------------------------

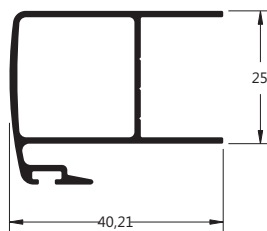

MG25-785

0,500 Kg/m

Montante central veneziana

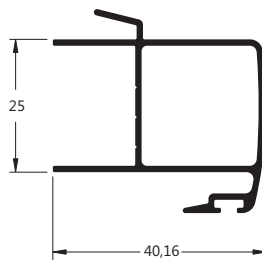

MG25-786

0,535 Kg/m

Montante intermediário veneziana

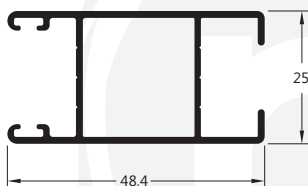

MG25-783

0,565 Kg/m

Montante da folha sem baguete

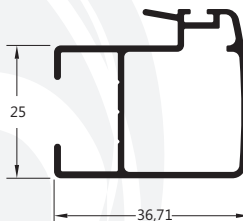

MG25-787

0,513 Kg/m

Montante central sem baguete

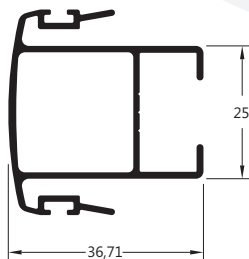

MG25-788

0,599 Kg/m

Montante central intermediário sem baguete

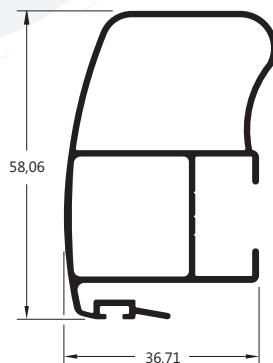

MG25-789

0,774 Kg/m

Montante central com reforço sem baguete

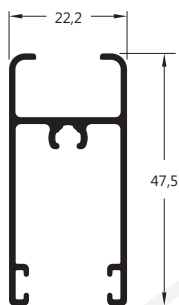

MG25-186

0,496 Kg/m

Travessa da folha

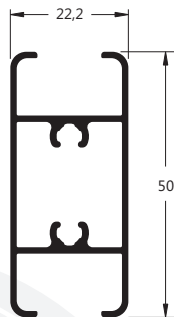

MG25-188

0,586 Kg/m

Travessa intermediaria da folha

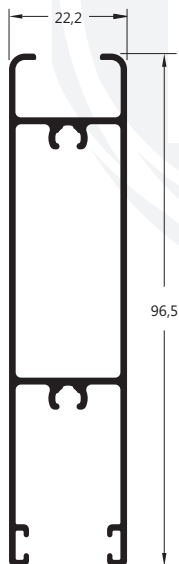

MG25-266

0,945 Kg/m

Travessa inferior da folha

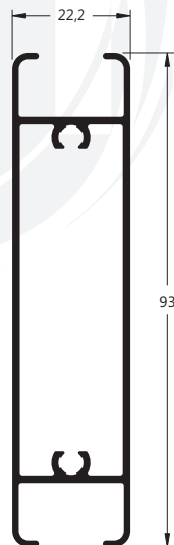

MG25-790

0,871 Kg/m

Travessa intermediária da folha

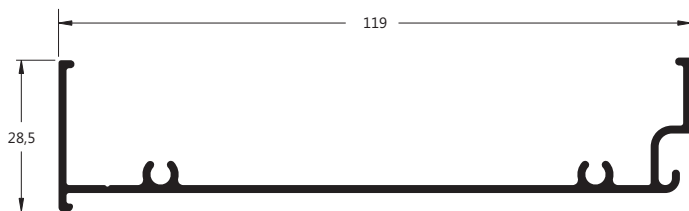

MG25-508

0,810 Kg/m

Marco superior integrada

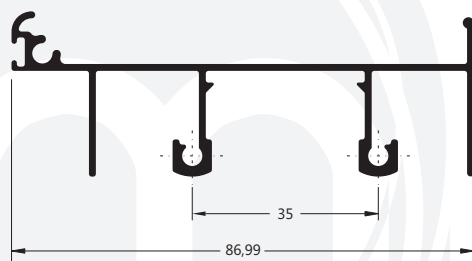

MG25-509

0,843 Kg/m

Marco intermediário integrada

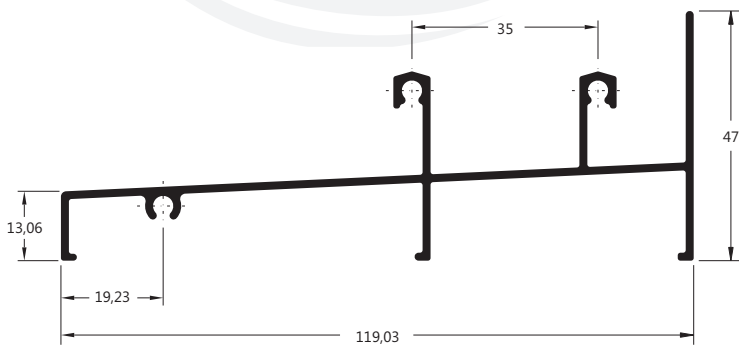

MG25-510

1,085 Kg/m

Trilho inferior integrada

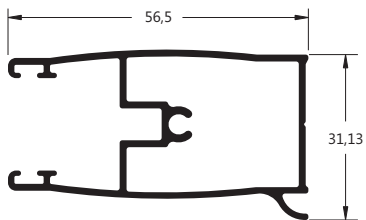

MG25-514	0,741 Kg/m	Complemento lateral persiana
----------	------------	------------------------------

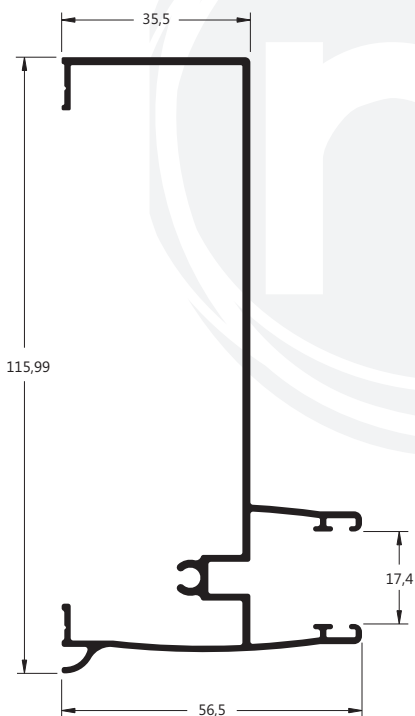

MG25-513	1,075 Kg/m	Complemento lateral persiana
----------	------------	------------------------------

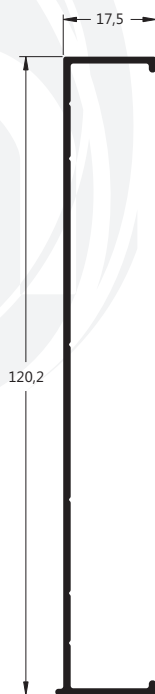

MG25-511	0,578 Kg/m	Marco lateral integrada
----------	------------	-------------------------

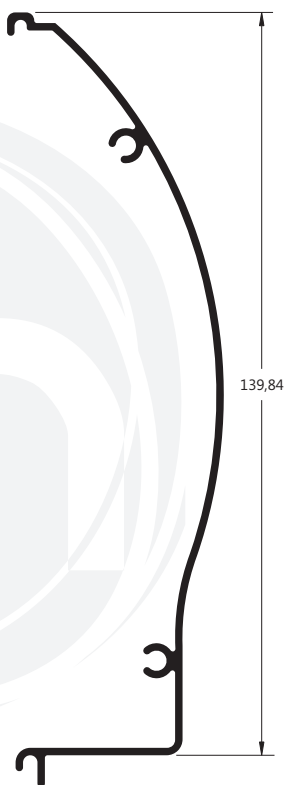
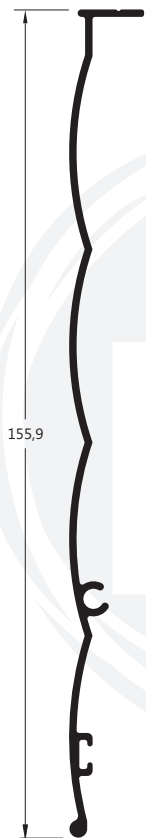

MG25-516

0,724 Kg/m

Tampa externa janela integrada

MG25-515

0,857 Kg/m

Tampa interna janela integrada

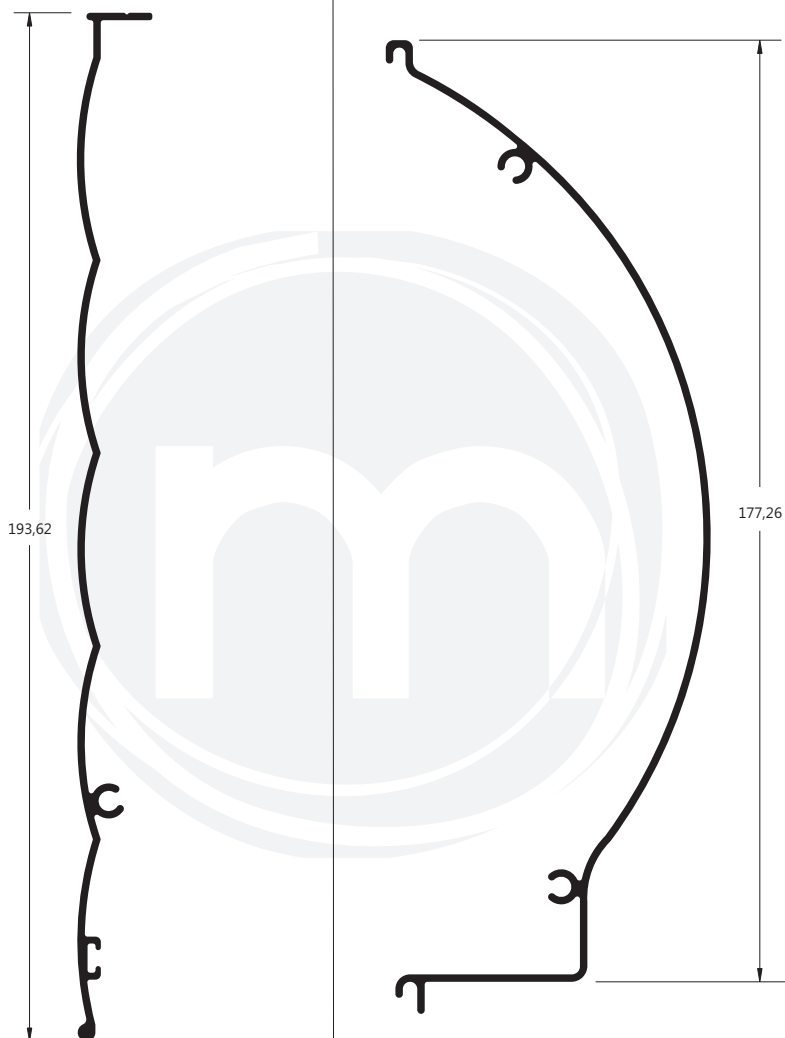

MG25-518

0,885 Kg/m

Tampa externa porta integrada

MG25-517

1,052 Kg/m

Tampa interna porta integrada

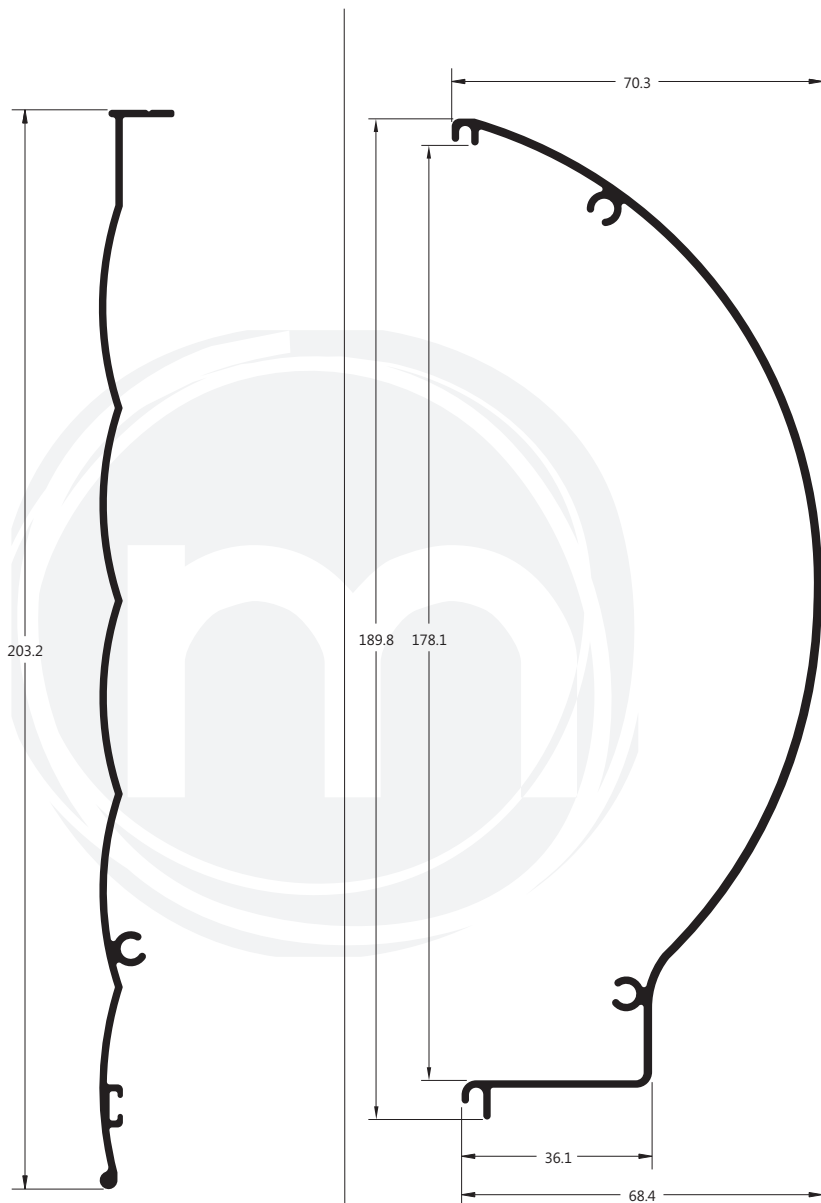

MG32-109

0,922 Kg/m

Tampa externa janela integrada

MG32-110

1,274 Kg/m

Tampa interna janela integrada

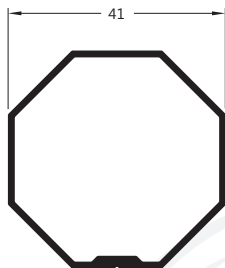

MG32-063

0,489 Kg/m

Tubo octogonal de 40 mm

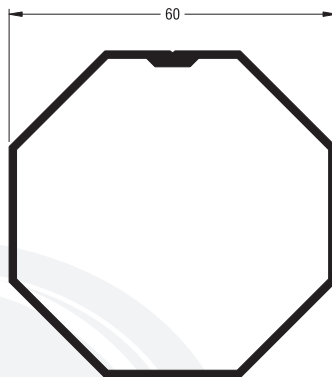

MG32-032

0,792 Kg/m

Tubo octogonal de 60 mm

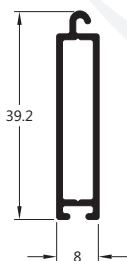

MG32-062

0,270 Kg/m

Lamina contra-peso de 39,2 mm

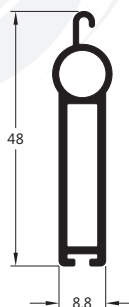

MG32-046

0,430 Kg/m

Lamina contra-peso de 48 mm

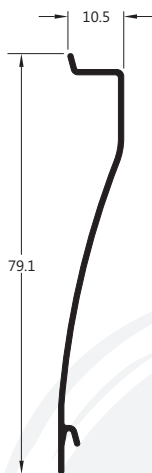

VA-012

0,255 Kg/m

Palheta veneziana 12 mm



VA-012F

0,255 Kg/m

Palheta veneziana 12 mm usinada

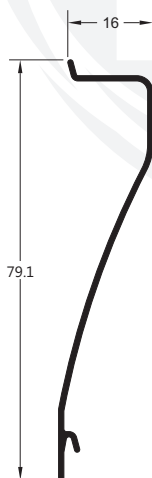

VA-017

0,274 Kg/m

Palheta veneziana 17 mm

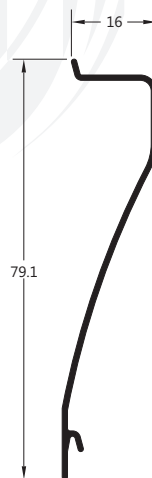

VA-017F

0,274 Kg/m

Palheta veneziana 17 mm usinada

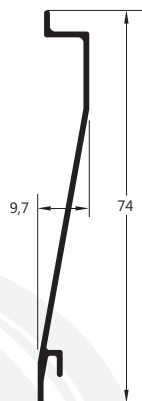
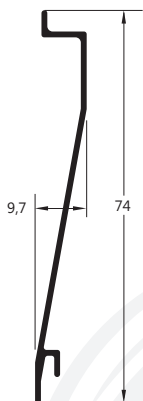

VA-024

0,271 Kg/m

Palheta veneziana 9,7 mm

VA-024F

0,271 Kg/m

Palheta veneziana 9,7 mm usinada

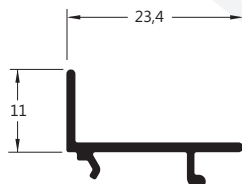

MG25-108

0,142 Kg/m

Baguete porta palheta

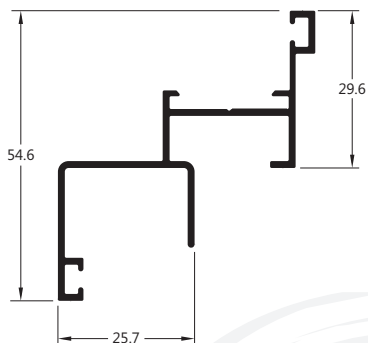

MG25-030

0,541 Kg/m

Marco perimetral maxim-ar

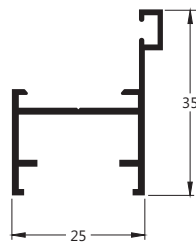

MG25-079

0,333 Kg/m

Marco perimetral maxim-ar

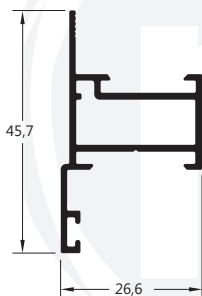

MG25-200

0,440 Kg/m

Montante com escova maxim-ar

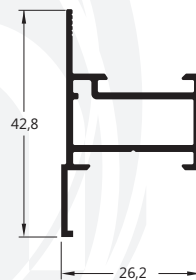

MG25-081

0,420 Kg/m

Montante sem escova maxim-ar

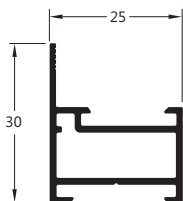

MG25-080

0,362 Kg/m

Travessa inferior maxim-ar 45°

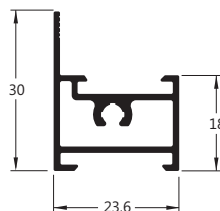

MG25-082

0,389 Kg/m

Travessa inferior maxim-ar 90°

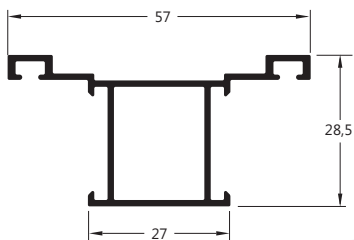

MG25-085

0,506 Kg/m

Travessa vertical
sem olhal maxim-ar

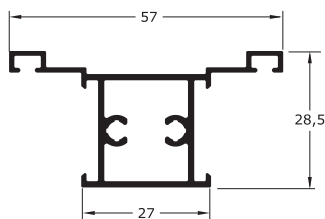

MG25-086

0,589 Kg/m

Travessa vertical
com olhal maxim-ar

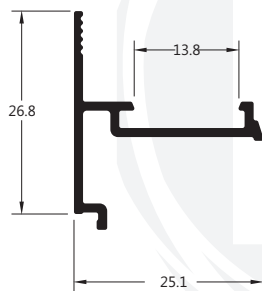

MG25-292

0,214 Kg/m

Reversor de Maxim-ar

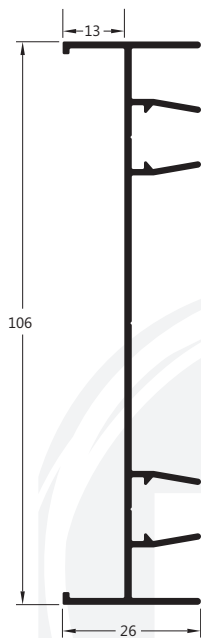

MG25-013

0,767 Kg/m

Marco lateral de correr
3 planos

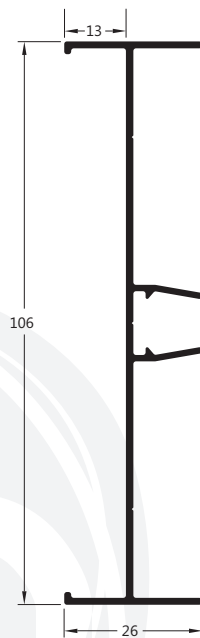

MG25-014

0,671 Kg/m

Marco lateral de correr
3 planos

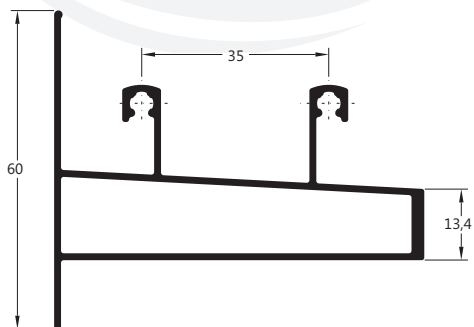

MG25-006

0,999 Kg/m

Trilho intermediário
correr 2 planos

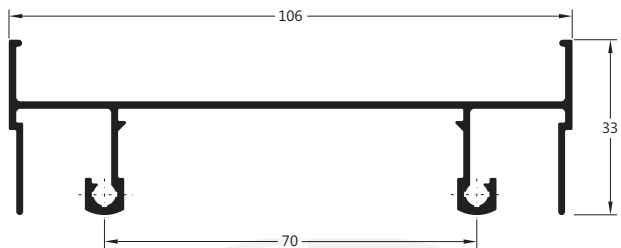

MG25-015

0,918 Kg/m

Trilho superior de
correr 2 planos

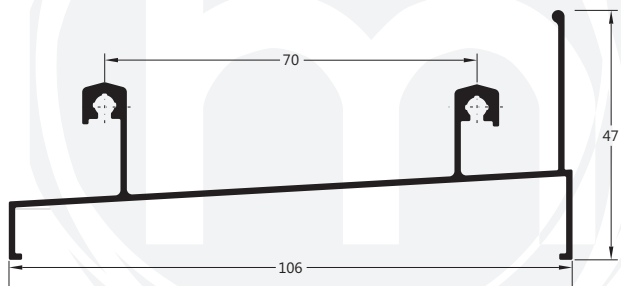

MG25-016

0,841 Kg/m

Trilho inferior de
correr 2 planos

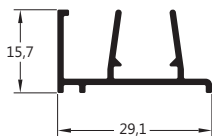

MG25-008

0,245 Kg/m

Mata junta

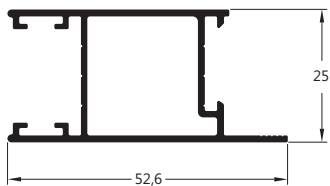

MG25-039

0,554 Kg/m

Montante da folha
com bagueete

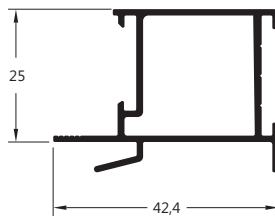

MG25-040

0,482 Kg/m

Montante central
interno da folha

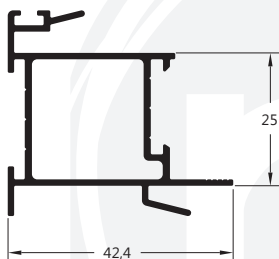

MG25-042

0,589 Kg/m

Montante central
intermediário da folha

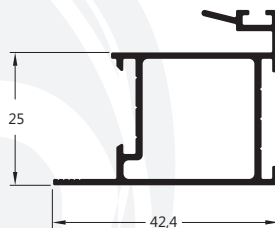

MG25-041

0,532 Kg/m

Montante central
externo da folha

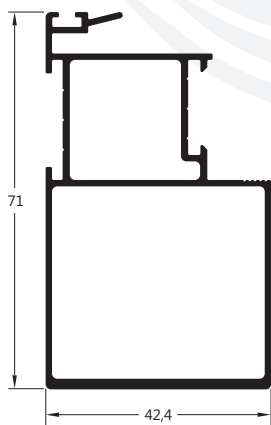

MG25-049

0,907 Kg/m

Montante bi-tubular
central externo

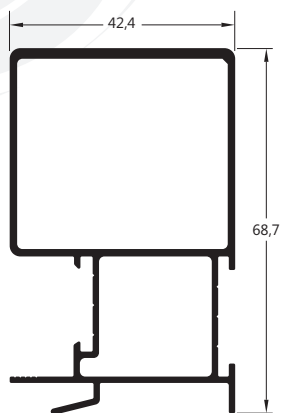

MG25-047

1,040 Kg/m

Montante bi-tubular
central interno

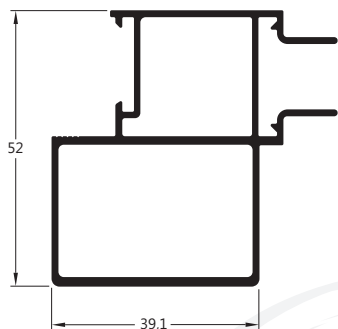

MG25-043 0,947 Kg/m Montante bi-tubular central da folha

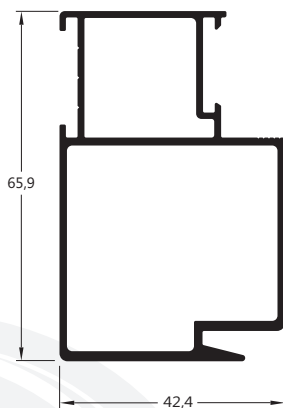

MG25-048 1,037 Kg/m Montante bi-tubular central interno

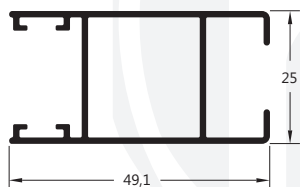

MG25-055 0,545 Kg/m Montante da folha sem baquete

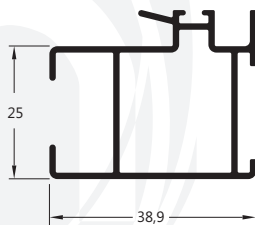

MG25-056 0,538 Kg/m Montante central sem baquete

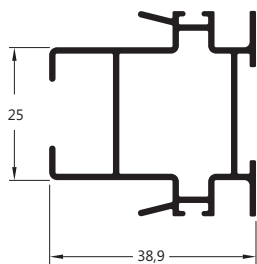

MG25-057 0,632 Kg/m Montante central intermediário sem baquete

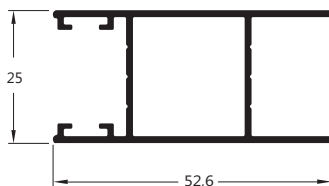

MG25-068 0,574 Kg/m Montante da folha veneziana

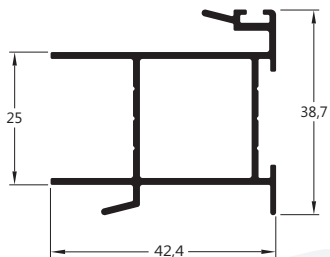

MG25-069 0,613 Kg/m Montante central intermediário veneziana

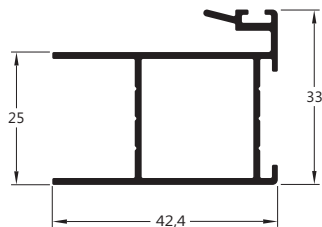

MG25-070 0,559 Kg/m Montante central externo veneziana

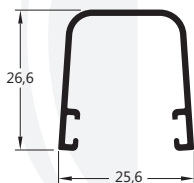

MG25-107 0,269 Kg/m Vedação da folha

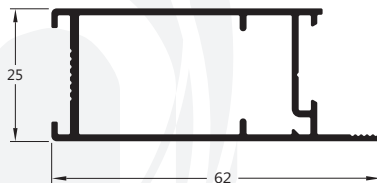

MG25-111 0,634 Kg/m Montante da folha com baquete

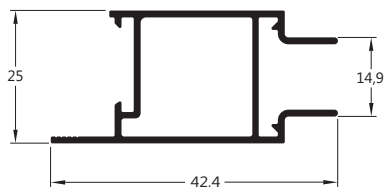

MG25-192 0,554 Kg/m Montante central da folha

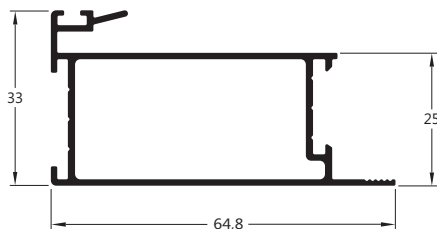

MG25-242 0,674 Kg/m Montante central externo da folha

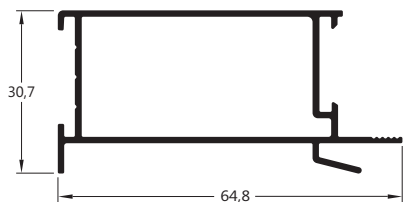

MG25-243

0,636 Kg/m

Montante central interno da folha

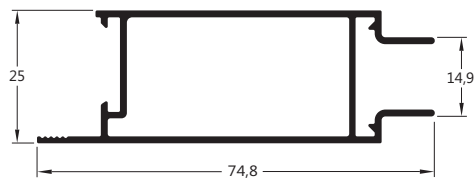

MG25-244

0,699 Kg/m

Montante central da folha

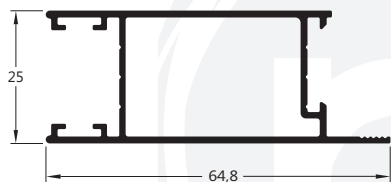

MG25-245

0,636 Kg/m

Montante central e lateral

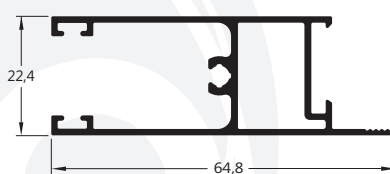

MG25-246

0,645 Kg/m

Montante inferior da folha

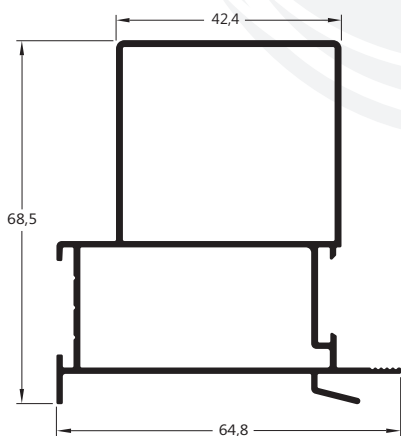

MG25-289

1,040 Kg/m

Montante bi-tubular central interno

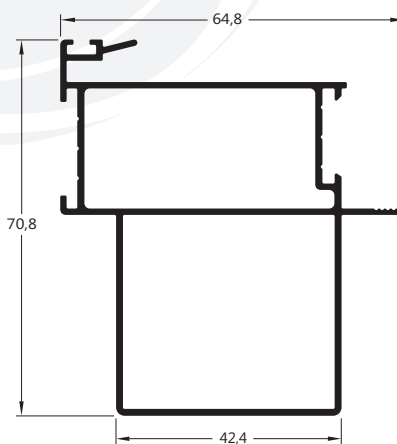

MG25-290

1,078 Kg/m

Montante bi-tubular central externo

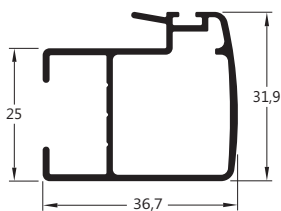

MG25-787

0,513 Kg/m

Montante central
sem baguete

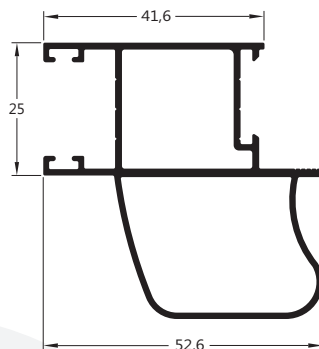

MG25-796

0,847 Kg/m

Montante lateral / central
da folha

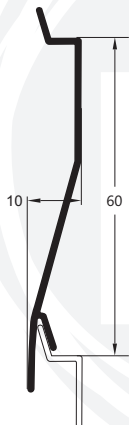

VA-201

0,261 Kg/m

Palheta veneziana 10 mm

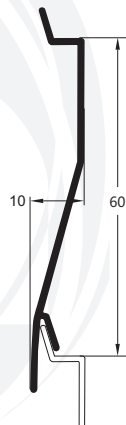

VA-201F

0,261 Kg/m

Palheta veneziana 10 mm usinada

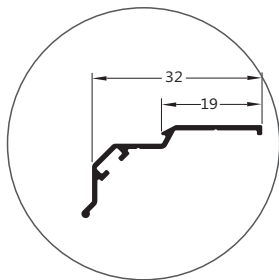

MG25-083

0,144 Kg/m

Pingadeira do marco
do maxim-ar

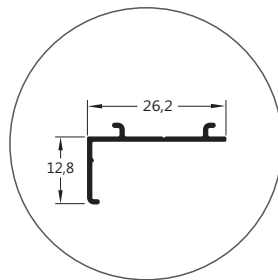

MG25-084

0,125 Kg/m

Pingadeira da folha
do maxim-ar

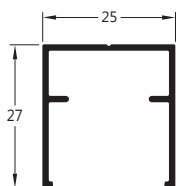

MG25-093 0,280 Kg/m Marco perimétrico para basculante

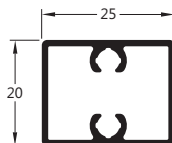

MG25-094 0,362 Kg/m Travessa para basculante

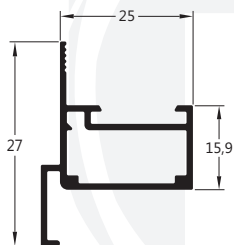

MG25-097 0,399 Kg/m Montante báscula

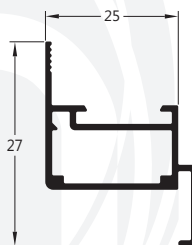

MG25-098 0,399 Kg/m Montante báscula

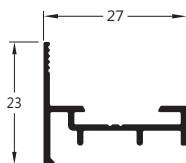

MG25-099 0,228 Kg/m Montante fixo

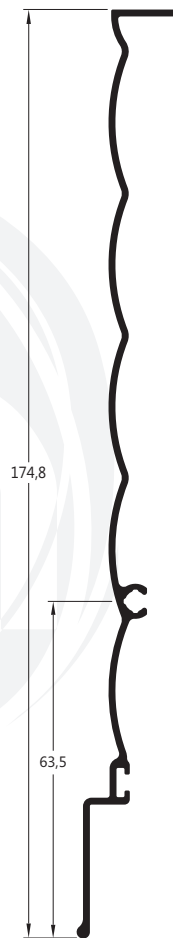
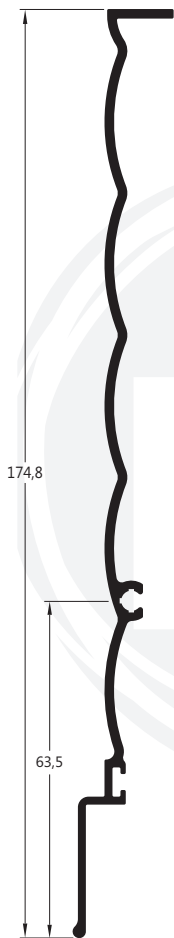

MG25-360

0,984 Kg/m

Tampa externa integrada

MG25-710

0,753 Kg/m

Tampa externa integrada

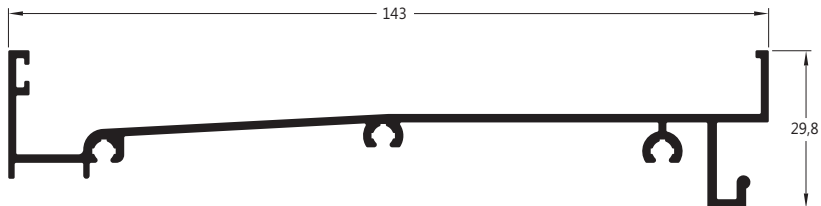

MG25-370

1,108 Kg/m

Marco superior integrada



MG25-380

0,794 Kg/m

Tampa interna lisa integrada

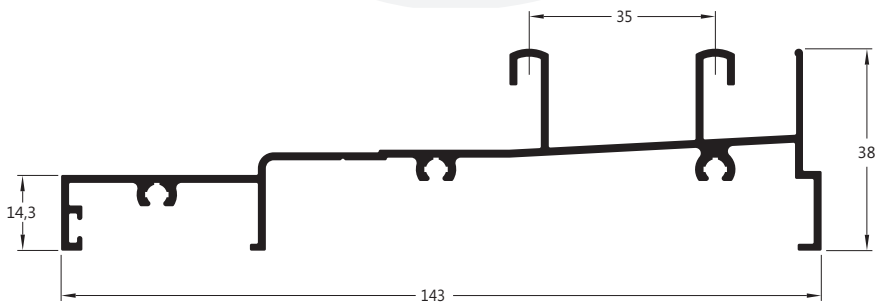

MG25-390

1,291 Kg/m

Trilho inferior integrada

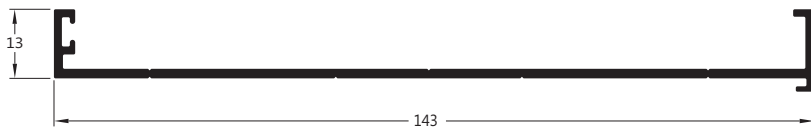

MG25-400 0,845 Kg/m Marco lateral integrada



MG25-420 1,207 Kg/m Complemento lateral persiana

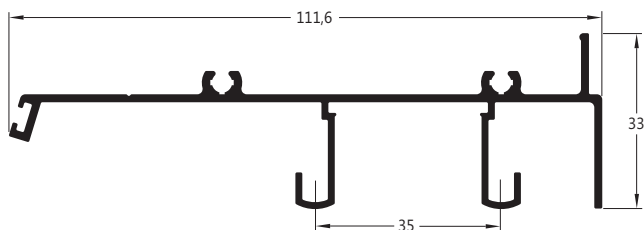

MG25-430 0,948 Kg/m Trilho intermediário integrada

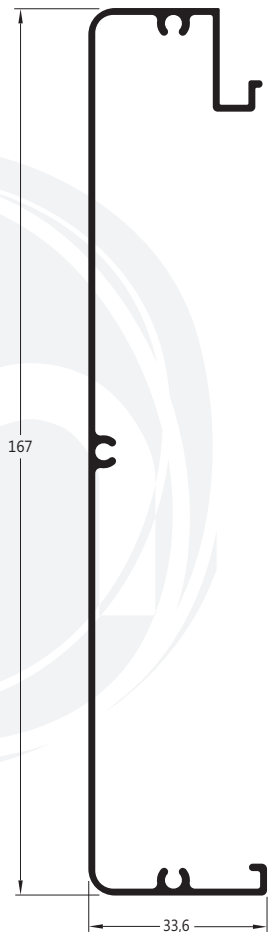
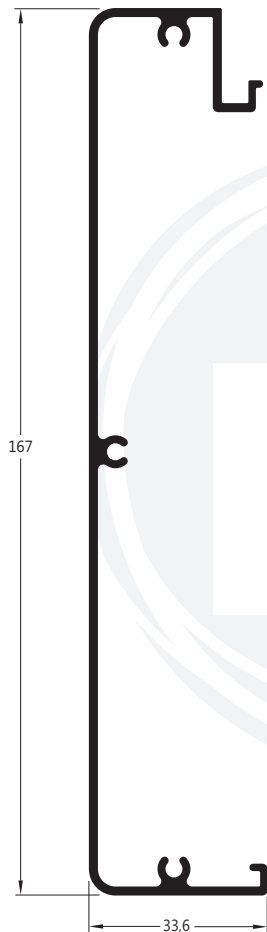

MG25-450

1,332 Kg/m

Tampa interna integrada

MG25-690

1,006 Kg/m

Tampa interna integrada

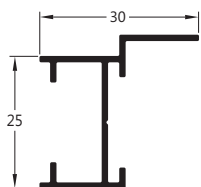

MG25-782

0,279 Kg/m

Marco perimétrico

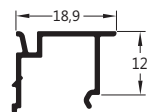

MG25-797

0,107 Kg/m

Baguete acoplador veneziana

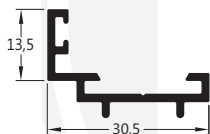

MG25-798

0,283 Kg/m

Batedeira porta de giro

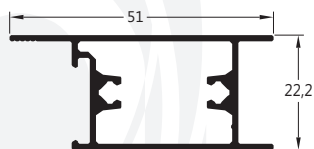

MG25-799

0,554 Kg/m

Montante da folha

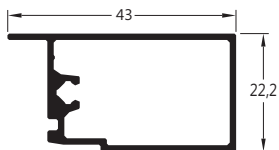

MG25-800

0,456 Kg/m

Montante folha

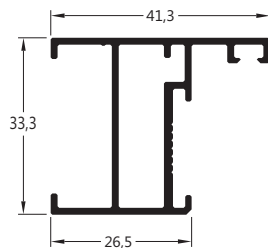

MG25-801

0,565 Kg/m

Marco Lateral





ACESSÓRIOS

Índice de acessórios

código	descrição	pág.	código	descrição	pág.
CHU-00787	Chumbador para contramarcos (natural)	72	NYLO00369BCO	Guia e limitador da persiana (branca)	70
COM00370BCO	Contra Fecho (branco)	60	NYLO00369PTO	Guia e limitador da persiana (preta)	70
COM00370FCO	Contra Fecho (fosco)	60	NYLO00370BCO	Guia da persiana em poliamida (branco)	68
COM00370PTO	Contra Fecho (preto)	60	NYLO00370PTO	Guia da persiana em poliamida (preto)	68
FEC00448BCO	Fecho concha (branco)	59	NYLO00420PTO	Botão tapa furo (preto)	63
FEC00448FCO	Fecho concha (fosco)	59	NYLO00447BCO	Tampa lateral da palheta (branca)	66
FEC00448PTO	Fecho concha (preto)	59	NYLO00447PTO	Tampa lateral da palheta (preta)	66
FEC1035	Fecho manual (fosco)	59	NYLO00738BCO	Limitador de abertura (branco)	70
FEC10350	Fecho manual (branco)	59	NYLO00738PTO	Limitador de abertura (preto)	70
FEC1035EB	Fecho concha (branco)	59	NYLO0190PTO	Presilha do arremate	71
FEC1036	Fecho automático (preto)	59	PALHETA	Esteira montada	66
FEC10360	Fecho automático (fosco)	59	PREO0965PTO	Presilha do arremate	71
FECH10006BCO	Fecho concha (branco)	59	REC-120	Recolhedor	69
FECH10006BZE	Fecho concha (bronze)	59	REC-120 EB	Recolhedor	69
FECH10006FCO	Fecho concha (fosco)	59	REC-121	Recolhedor	69
FECH10006PTO	Fecho concha (preto)	59	REC-121 EB	Recolhedor	69
FECH1036EB	Fecho automático (branco)	59	REC-122	Recolhedor	69
FITASB05X05BCO	Fita vedadora sem barreira plástica 5x5 mm	73	REC-122 EB	Recolhedor	69
FITASB05X06BCO	Fita vedadora sem barreira plástica 5x6 mm	73	REC-123	Recolhedor	69
FITASB05X08BCO	Fita vedadora sem barreira plástica 5x8mm	73	REC-123 EB	Recolhedor	69
FITO007490	Mola de segurança p/ fixação da esteira	68	ROL-439R	Roldana dupla c/ regulagem (com regulamento)	61
GUAR00157PTO	Guarnição em epdm (vidro de 4 mm)	74	ROLD00426BCO	Roldana com regulagem (sem rolamento)	61
GUAR00256PTO	Guarnição em epdm (vidro de 4 e 5 mm)	74	ROLD00426PTO	Roldana com regulagem (sem rolamento)	61
GUAR00258PTO	Guarnição em epdm (vidro de 5 e 6 mm)	74	ROLD00439BCO	Roldana dupla c/ regulagem (sem regulamento)	61
GUAR00259PTO	Guarnição em epdm (vidro de 6 mm)	74	ROLD00439PTO	Roldana dupla c/ regulagem (sem regulamento)	61
GUAR00283PTO	Guarnição em epdm (vidro de 5 e 6 mm)	74	ROLD00440BCO	Roldana com regulagem (com rolamento)	61
GUAR00284PTO	Guarnição em epdm (vidro de 4 mm)	74	ROLD00440PTO	Roldana com regulagem (com rolamento)	61
GUIA10001BCO	Guia limitadora (branca)	60	TAMP10015BCO	Tampa superior e inferior (branca)	64
GUIA10001PTO	Guia limitadora (preta)	60	TAMP10015PTO	Tampa superior e inferior (preta)	64
GUIA10002BCO	Guia da cinta do recolhedor (branca)	67	TAMP10018BCO	Tampa lateral da porta com persiana (branca)	64
GUIA10002PTO	Guia da cinta do recolhedor (preta)	67	TAMP10018PTO	Tampa lateral da porta com persiana (preta)	64
GUIA10003BCO	Guia central da persiana (branca)	67	TAMP10014BCO	Tampa lateral da janela c/ persiana (branca)	65
GUIA10003PTO	Guia central da persiana (preta)	67	TAMP10014PTO	Tampa lateral da janela c/ persiana (preta)	65
NYLO0014BCO	Batedeira (branca)	63	TAMP10016BCO	Tampa lateral da janela c/ persiana (branca)	65
NYLO0014PTO	Batedeira (preta)	63	TAMP10016PTO	Tampa lateral da janela c/ persiana (preta)	65
NYLO0024BCO	Botão tapa furo (branco)	63			
NYLO00329BCO	Vedação inferior (branca)	62			
NYLO00329PTO	Vedação inferior (preta)	62			
NYLO00335BCO	Vedação superior (branca)	62			
NYLO00335PTO	Vedação superior (preta)	62			

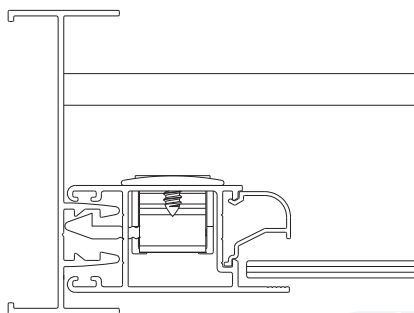

DETALHE DE APLICAÇÃO
sem escala

Código	Descrição
FECH10006PTO	Fecho conha (preto)
FECH10006FCO	Fecho conha (fosco)
FECH10006BZE	Fecho conha (bronze)
FECH10006BCO	Fecho conha (branco)

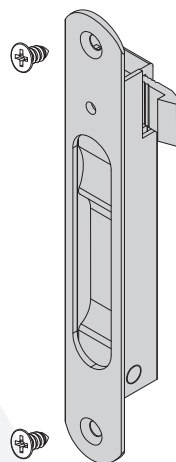

PERSPECTIVA
sem escala

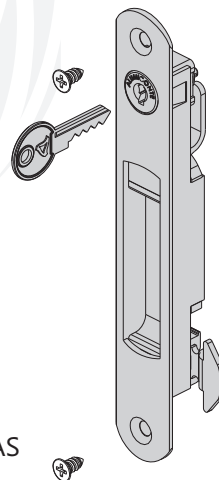
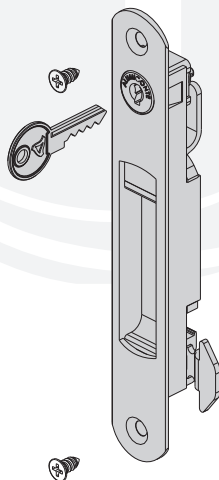
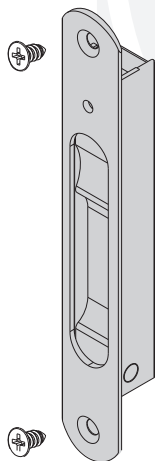

PERSPECTIVAS
sem escala

Código	Descrição
FEC00448PTO	Fecho conha (preto)
FEC00448FCO	Fecho conha (fosco)
FEC00448BCO	Fecho conha (branco)

Código	Descrição
FEC1035	Fecho manual (preto)
FEC10350	Fecho manual (fosco)
FEC1035EB	Fecho manual (branco)

Código	Descrição
FEC1036	Fecho autom. (preto)
FEC10360	Fecho autom. (fosco)
FEC1036EB	Fecho autom. (branco)

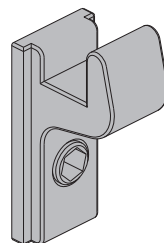
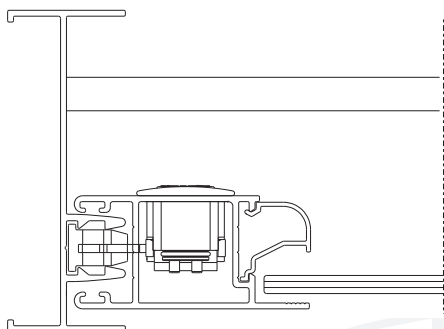

DETALHE DE APLICAÇÃO

sem escala

Código	Descrição
COM00370PTO	Contra fecho (preto)
COM00370FCO	Contra fecho (fosco)
COM00370BCO	Contra fecho (branco)

PERSPECTIVA
sem escala

Código (ver tabela)

Contra fecho

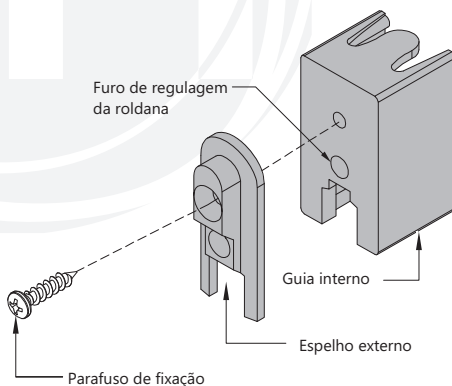
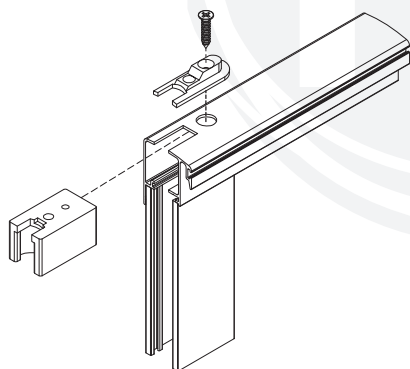

DETALHE DE APLICAÇÃO

sem escala

Código	Descrição
GUIA10001PTO	Guia limitadora (preta)
GUIA10001BCO	Guia limitadora (branca)

PERSPECTIVA
sem escala

Código (ver tabela)

Guia limitadora

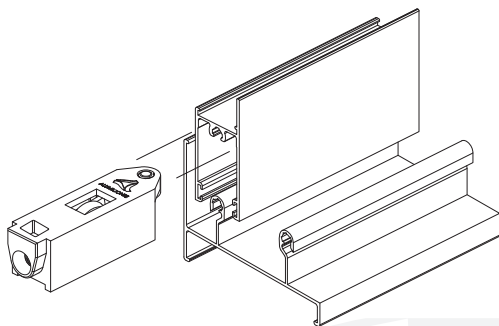

DETALHE DE APLICAÇÃO
sem escala

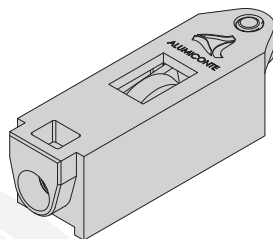

PERSPECTIVA
sem escala

Código	Descrição
ROLD00426PTO	Roldana com regulagem (sem rolamento)
ROLD00426BCO	Roldana com regulagem (sem rolamento)
ROLD00440PTO	Roldana com regulagem (com rolamento)
ROLD00440BCO	Roldana com regulagem (com rolamento)

Código (ver tabela)	Roldana com regulagem
---------------------	-----------------------

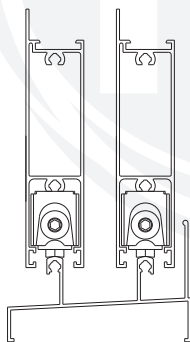

DETALHE DE APLICAÇÃO
sem escala

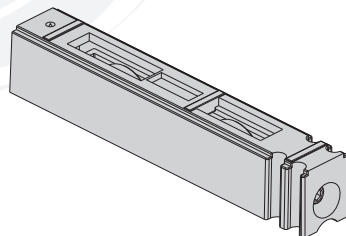

PERSPECTIVA
sem escala

Código	Descrição
ROLD00439PTO	Roldana dupla c/ regulagem (sem rolamento)
ROLD00439BCO	Roldana dupla c/ regulagem (sem rolamento)
ROL-439R	Roldana dupla c/ regulagem (com rolamento)

Código (ver tabela)	Roldana dupla com regulagem
---------------------	-----------------------------

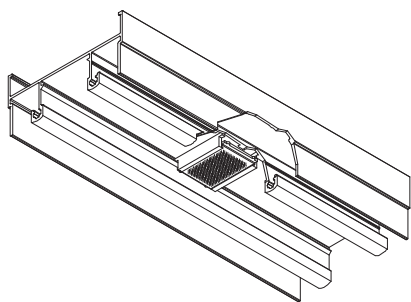

DETALHE DE APLICAÇÃO
sem escala

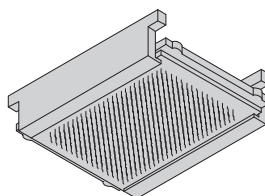

PERSPECTIVA
sem escala

Código	Descrição
NYLO00335PTO	Vedação superior (preta)
NYLO00335BCO	Vedação superior (branca)
Código (ver tabela)	Vedação superior

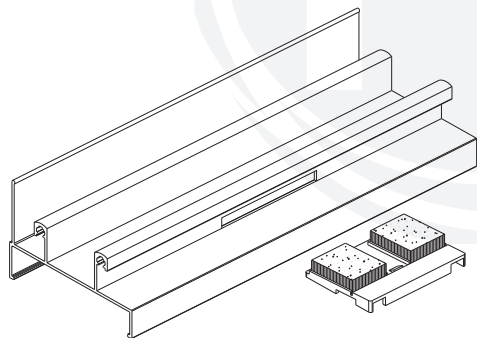

DETALHE DE APLICAÇÃO
sem escala

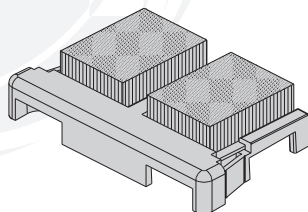

PERSPECTIVA
sem escala

Código	Descrição
NYLO00329PTO	Vedação inferior (preta)
NYLO00329BCO	Vedação inferior (branca)
Código (ver tabela)	Vedação inferior

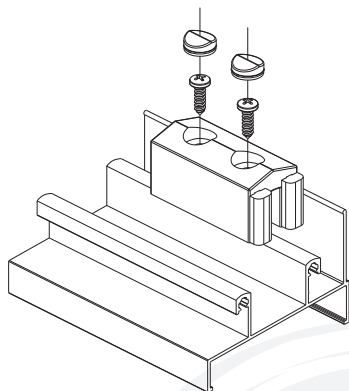

DETALHE DE APLICAÇÃO

sem escala

Código	Descrição
NYLO00414PTO	Batedeira (preta)
NYLO00414BCO	Batedeira (branca)

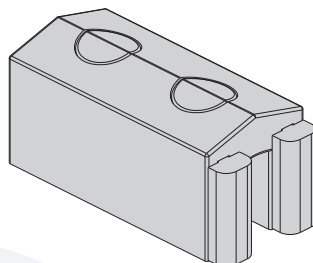

PERSPECTIVA

sem escala

Código (ver tabela)	Batedeira
---------------------	-----------

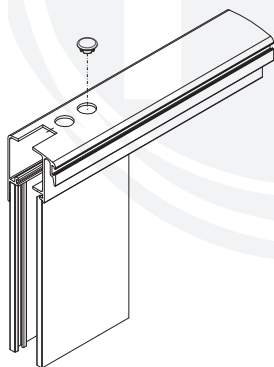

DETALHE DE APLICAÇÃO

sem escala

Código	Descrição
NYLO00420PTO	Botão tapa furo (preto)
NYLO00420BCO	Botão tapa furo (branco)

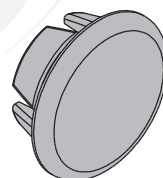

PERSPECTIVA

sem escala

Código (ver tabela)	Botão tapa furo
---------------------	-----------------

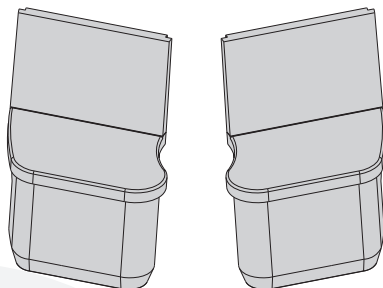

DETALHE DE APLICAÇÃO

sem escala

Código	Descrição
TAMP10015PTO	Tampa superior e inferior (preta)
TAMP10015BCO	Tampa superior e inferior (branca)

PERSPECTIVA

sem escala

Código (ver tabela)

Tampa superior e inferior

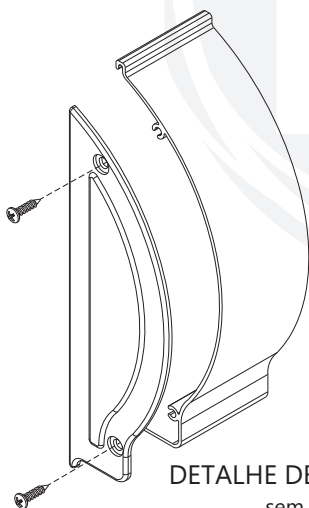

DETALHE DE APLICAÇÃO

sem escala

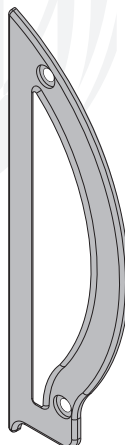

PERSPECTIVA

sem escala

Código	Descrição
TAMP10018PTO	Tampa lateral da porta com persiana (preta)
TAMP10018BCO	Tampa lateral da porta com persiana (branca)

Código (ver tabela)

Tampa lat. da porta com persiana integrada

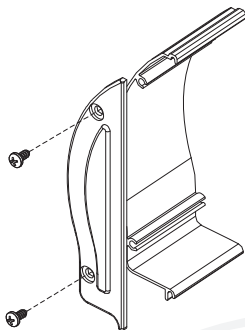

DETALHE DE APLICAÇÃO
sem escala

Código	Descrição
TAMPA10014PTO	Tampa lateral da janela c/persiana (preta)
TAMPA10014BCO	Tampa lateral da janela c/persiana (branca)

Código (ver tabela)

Tampa lat. da janela c/persiana integrada

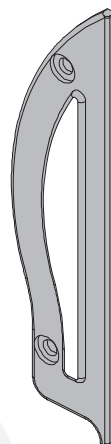

PERSPECTIVA
sem escala

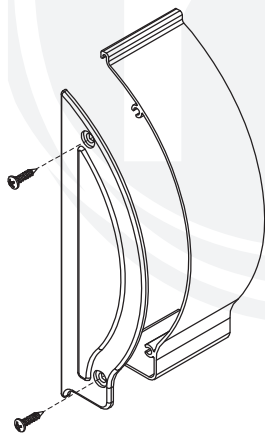

DETALHE DE APLICAÇÃO
sem escala

Código	Descrição
TAMPA10016PTO	Tampa lateral da janela c/persiana (preta)
TAMPA10016BCO	Tampa lateral da janela c/persiana (branca)

Código (ver tabela)

Tampa lat. da janela c/persiana integrada

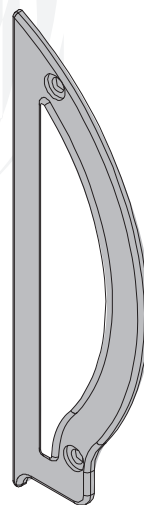

PERSPECTIVA
sem escala

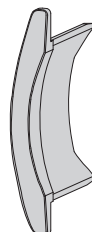
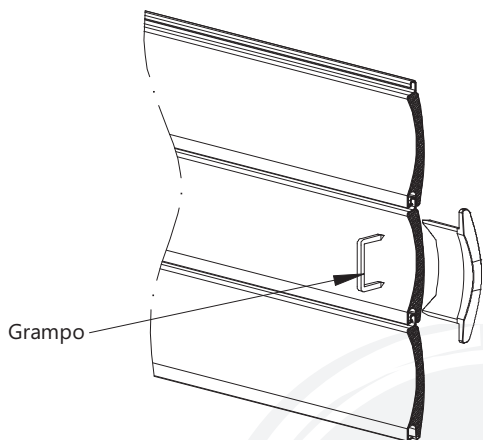

DETALHE DE APLICAÇÃO

sem escala

PERSPECTIVA

sem escala

Código	Descrição
NYLO00447PTO	Tampa lateral da palheta (preta)
NYLO00447BCO	Tampa lateral da palheta (branca)

Código (ver tabela)

Tampa lateral da palheta

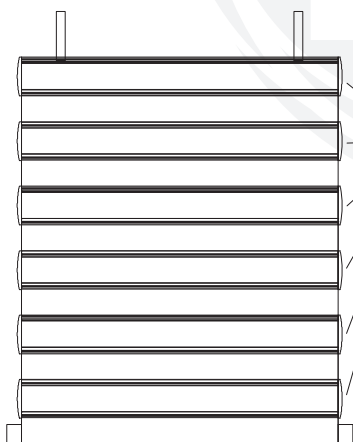

NYLO00447

Poliuretano
injetado

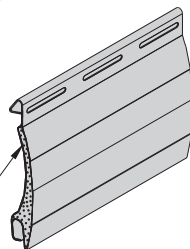

DETALHE DE APLICAÇÃO

sem escala

PERSPECTIVA

sem escala

Palheta

Esteira montada

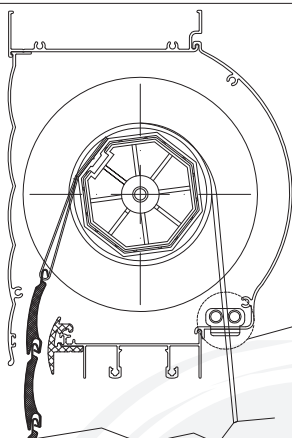

DETALHE DE APLICAÇÃO
sem escala

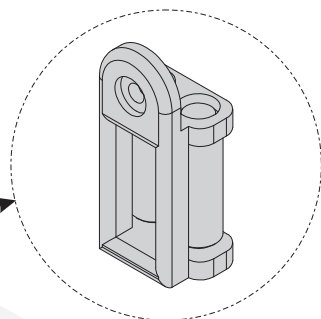

PERSPECTIVA
sem escala

Código	Descrição
GUIA10002PTO	Guia da cinta do recolhedor (preta)
GUIA10002BCO	Guia da cinta do recolhedor (branca)

Código (ver tabela)	Guia da cinta do recolhedor em poliamida
---------------------	--

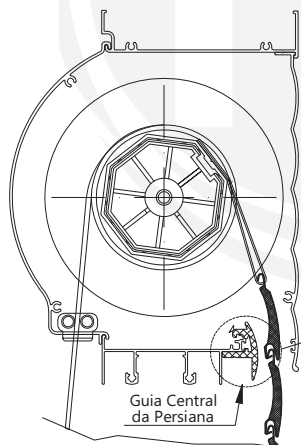

DETALHE DE APLICAÇÃO
sem escala

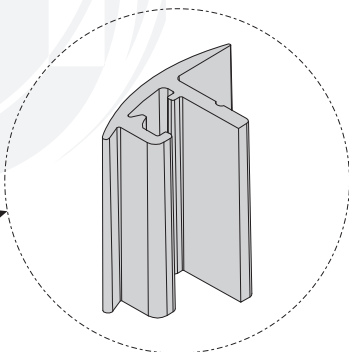

PERSPECTIVA
sem escala

Código	Descrição
GUIA10003PTO	Guia central da persiana em poliamida (preta)
GUIA10003BCO	Guia central da persiana em poliamida (branca)

Código (ver tabela)	Guia central da persiana em poliamida
---------------------	---------------------------------------

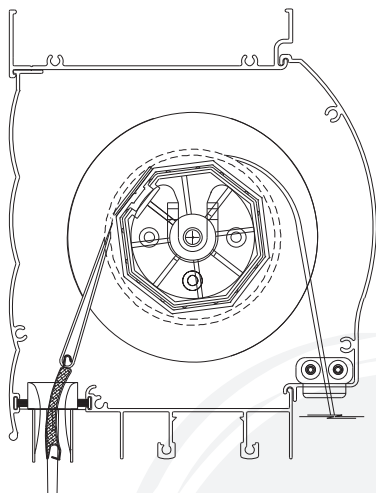

DETALHE DE APLICAÇÃO
sem escala

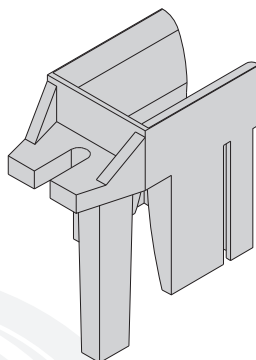

PERSPECTIVA
sem escala

Código	Descrição
NYLO00370PTO	Guia da persiana em poliamida (preto)
NYLO00370BCO	Guia da persiana em poliamida (branco)

Código (ver tabela)	Guia da persiana em poliamida
---------------------	-------------------------------

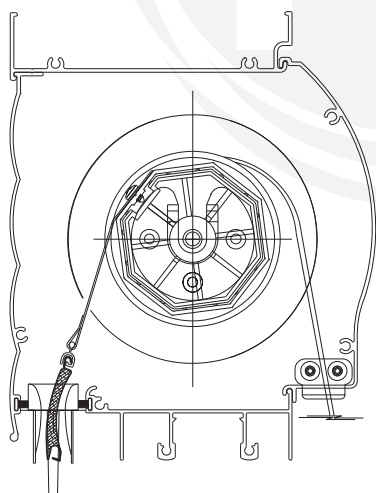

DETALHE DE APLICAÇÃO
sem escala

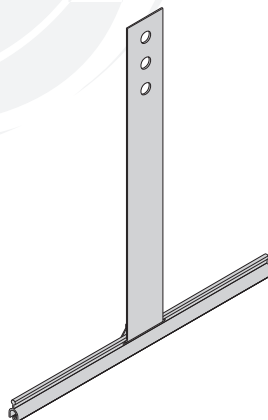

PERSPECTIVA
sem escala

FITO007490	Mola de segurança para fixação da esteira
------------	---

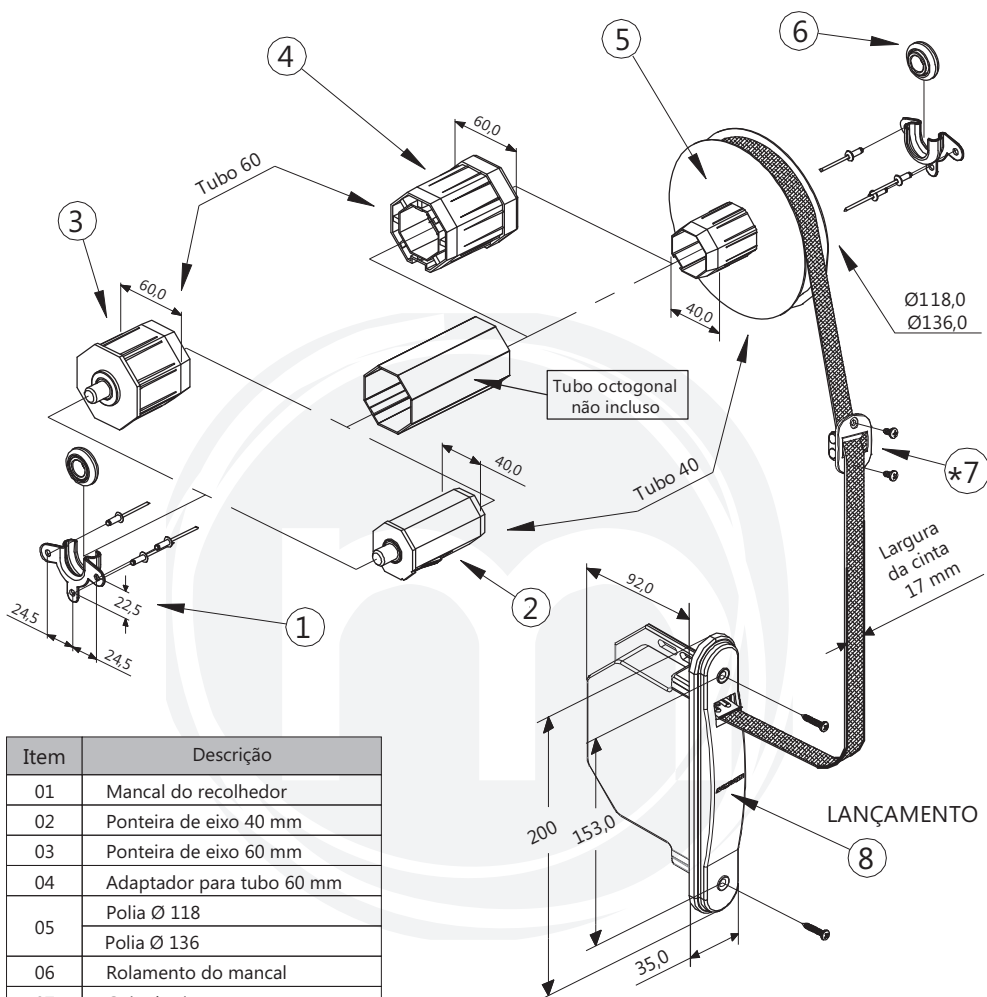

Item	Descrição
01	Mancal do recolhedor
02	Ponteira de eixo 40 mm
03	Ponteira de eixo 60 mm
04	Adaptador para tubo 60 mm
05	Polia Ø 118
	Polia Ø 136
06	Rolamento do mancal
07	Guia da cinta
08	Máquina com espelho e caixa

Código (preto)	Código (branco)	Tubo (mm)	Polia (mm)	Aplicação
REC-120	REC-120 EB	40	Ø 118	Janela
REC-121	REC-121 EB	40	Ø 136	Porta
REC-122	REC-122 EB	60	Ø 118	Janela
REC-123	REC-123 EB	60	Ø 136	Porta

Código (ver tabela)

Recolhedor

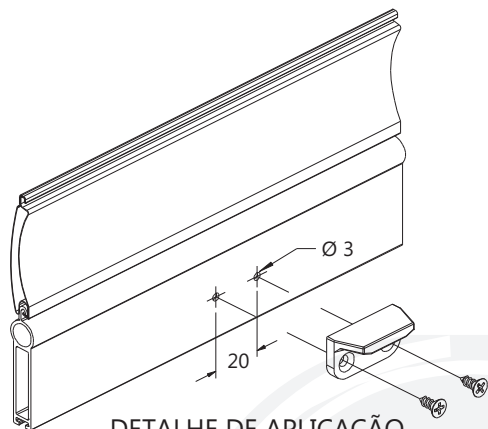

DETALHE DE APLICAÇÃO
sem escala

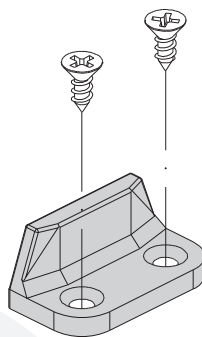

PERSPECTIVA
sem escala

Código	Descrição
NYLO00738PTO	Limitador de abertura (preto)
NYLO00738BCO	Limitador de abertura (branco)

Código (ver tabela)	Limitador de abertura
---------------------	-----------------------

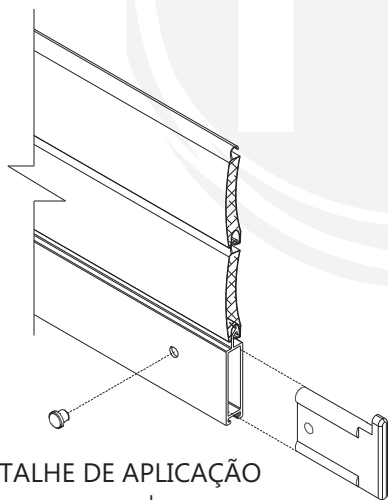

DETALHE DE APLICAÇÃO
sem escala

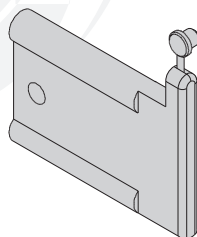

PERSPECTIVA
sem escala

Código	Descrição
NYLO00369PTO	Guia e limitador da persiana (preta)
NYLO00369BCO	Guia e limitador da persiana (branca)

NYLO00369	Guia e limitador da persiana
-----------	------------------------------

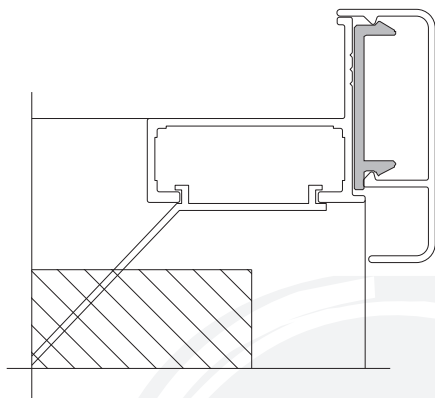

DETALHE DE APLICAÇÃO
sem escala

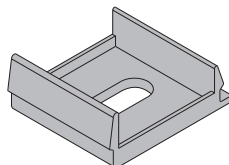

PERSPECTIVA
sem escala

PREO0965PTO

Presilha do arremate

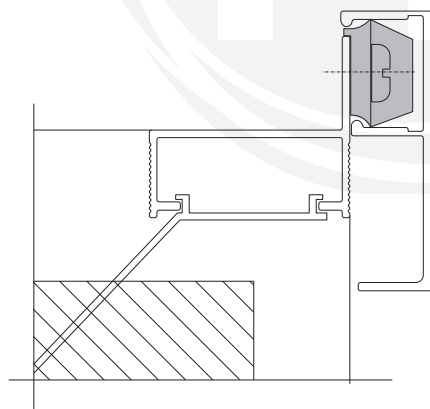

DETALHE DE APLICAÇÃO
sem escala

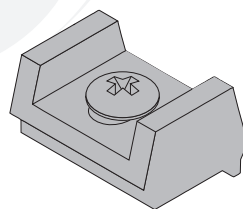

PERSPECTIVA
sem escala

NYLO0190PTO

Presilha do arremate

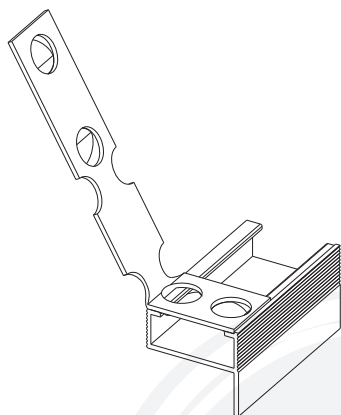

DETALHE DE APLICAÇÃO
sem escala

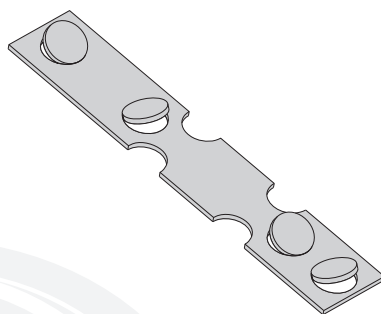

PERSPECTIVA
sem escala

CHU-00787

Chumbador para contramarcos (natural)

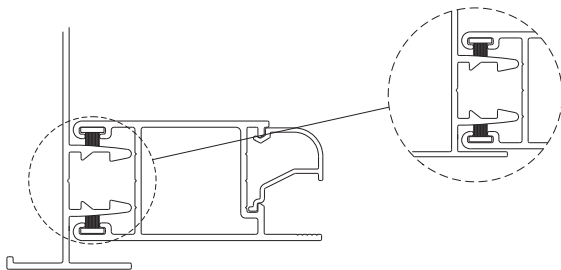

DETALHES DE APLICAÇÃO

sem escala

FITASB05X05BCO

Fita vedadora s/ barreira plástica 5 x 5 mm

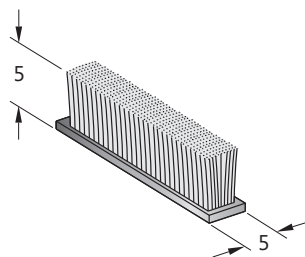

PERSPECTIVA

sem escala

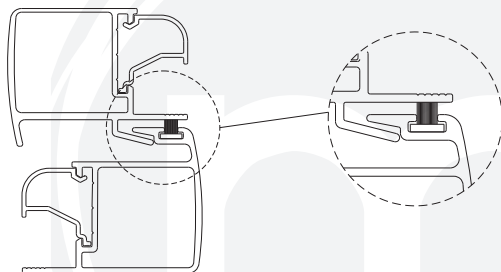

DETALHES DE APLICAÇÃO

sem escala

FITASB05X06BCO

Fita vedadora s/ barreira plástica 5 x 6 mm

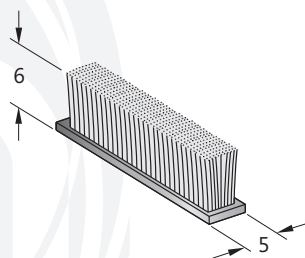

PERSPECTIVA

sem escala

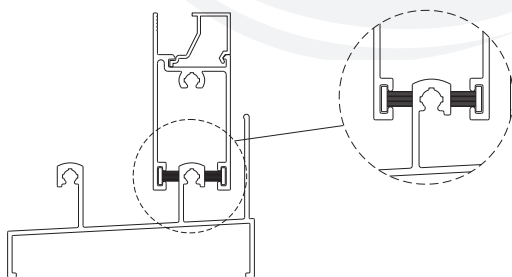

DETALHES DE APLICAÇÃO

sem escala

FITASB05X08BCO

Fita vedadora s/ barreira plástica 5 x 8 mm

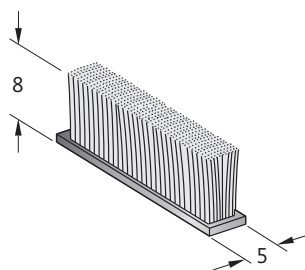

PERSPECTIVA

sem escala

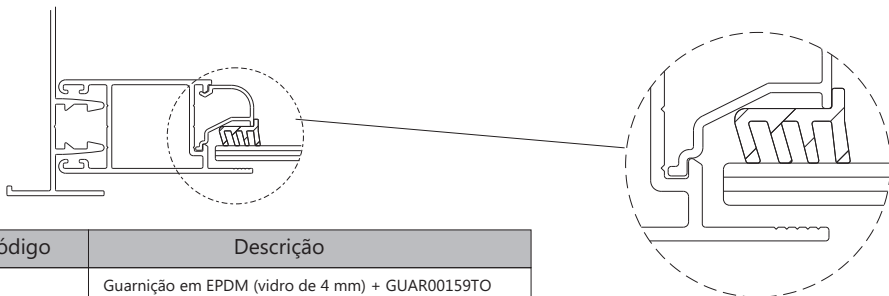

Código	Descrição
GUAR00256PTO	Guarnição em EPDM (vidro de 4 mm) + GUAR00159TO
	Guarnição em EPDM (vidro de 5 mm) + GUAR00258PTO
GUAR00259PTO	Guarnição em EPDM (vidro de 6 mm) + GUAR00258PTO

Código (ver tabela)	Guarnição em EPDM (preta)
---------------------	---------------------------

DETALHE DE APLICAÇÃO
sem escala



Código	Descrição
GUAR00157PTO	Guarnição em EPDM (vidro de 4 mm)
GUAR00258PTO	Guarnição em EPDM (vidro de 5 mm)
	Guarnição em EPDM (vidro de 6 mm)

Código (ver tabela)	Guarnição em EPDM (preta)
---------------------	---------------------------

DETALHE DE APLICAÇÃO
sem escala



Código	Descrição
GUAR00284PTO	Guarnição em EPDM (vidro de 4 mm)
GUAR00283PTO	Guarnição em EPDM (vidro de 5 mm)
	Guarnição em EPDM (vidro de 6 mm)

Código (ver tabela)	Guarnição em EPDM (preta)
---------------------	---------------------------

DETALHE DE APLICAÇÃO
sem escala



GRÁFICOS

Central 4 Folhas

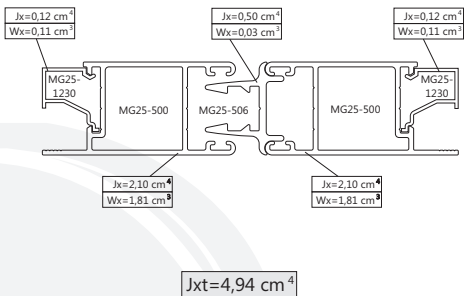
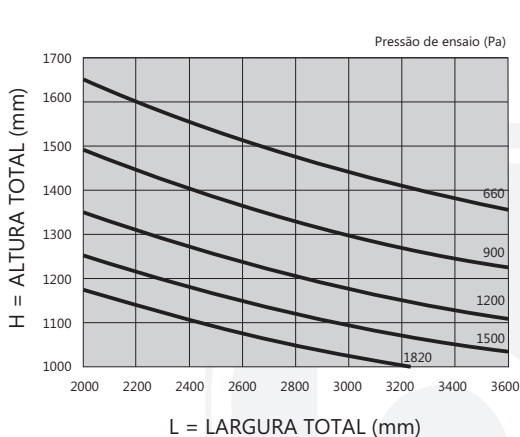
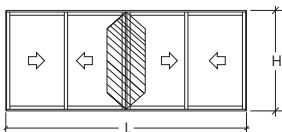

Montante Central

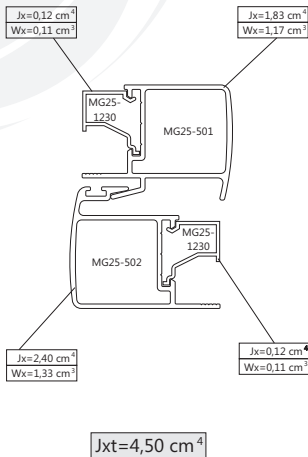
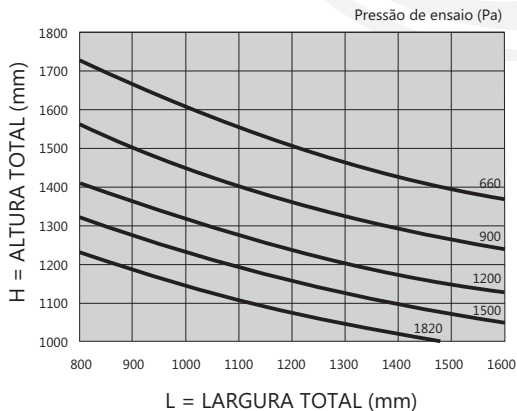
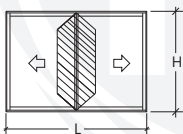

Montante Central

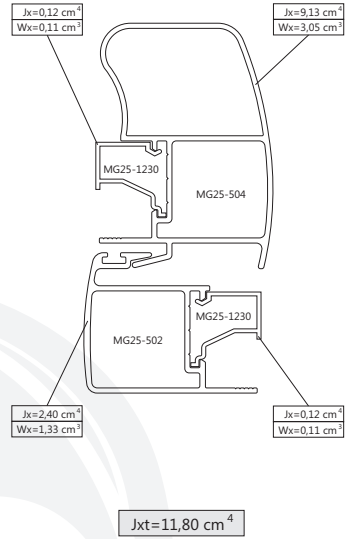
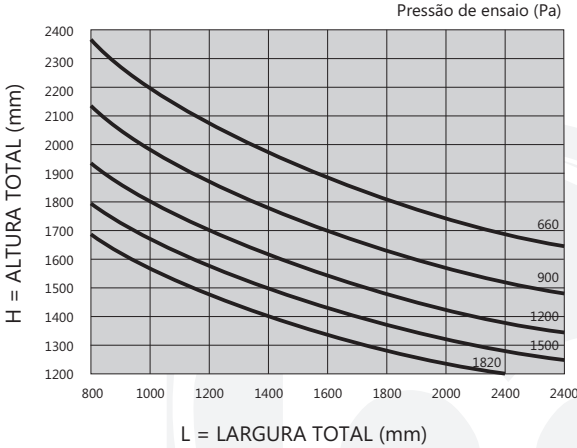
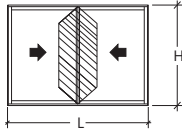

Montante Central

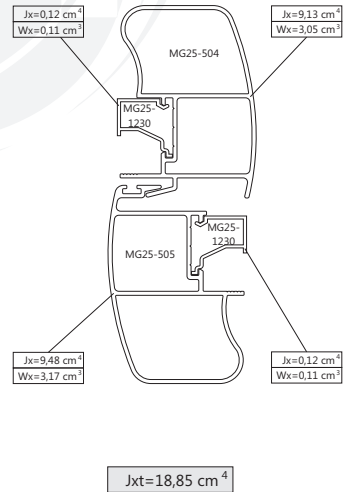
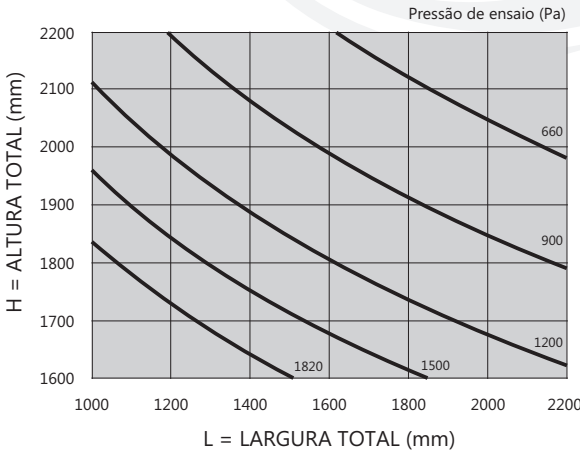
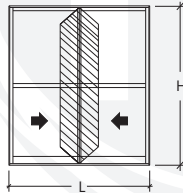

Montante Central

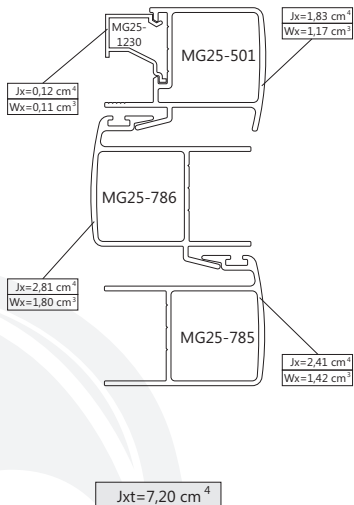
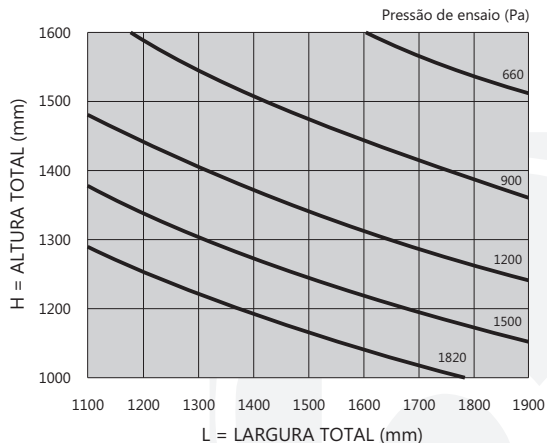
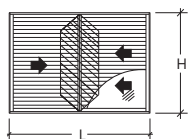

Montante Central

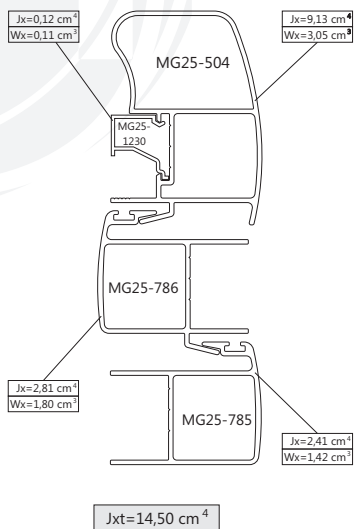
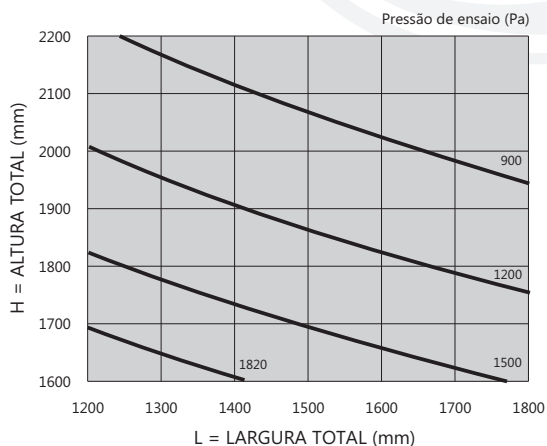
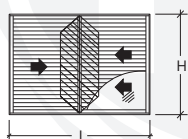

Montante Central

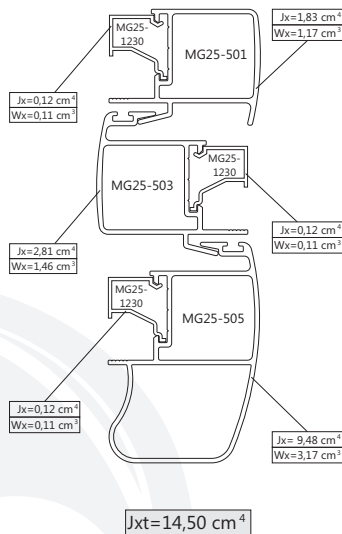
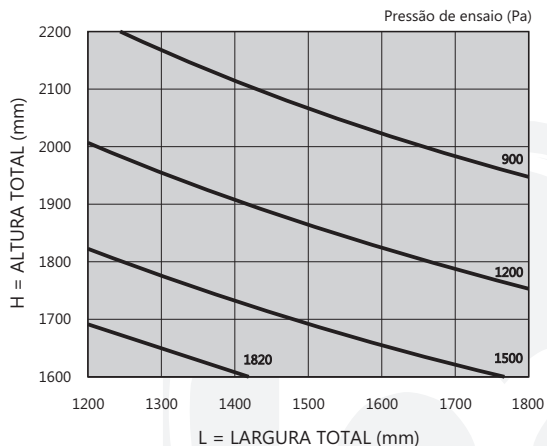
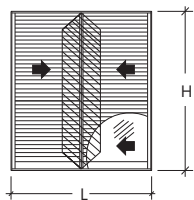

Montante Central

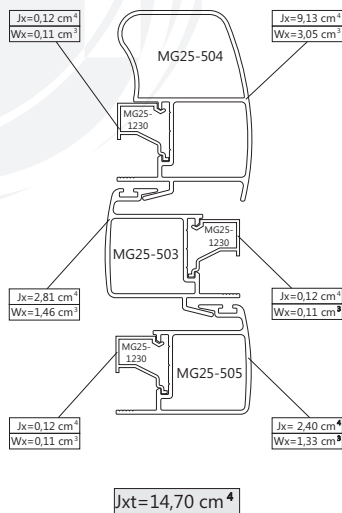
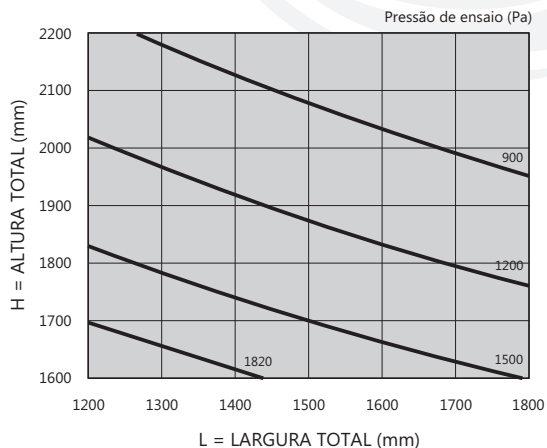
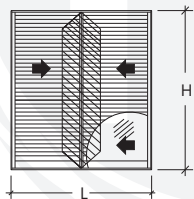

Montante Central

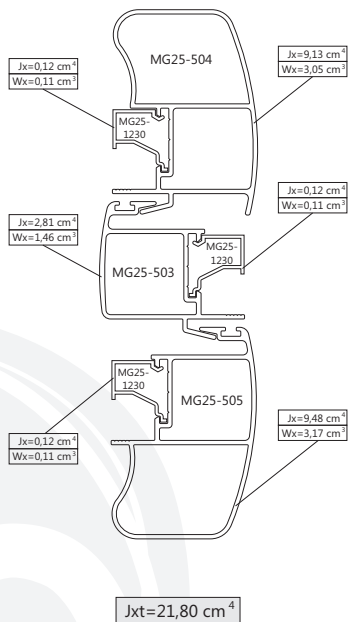
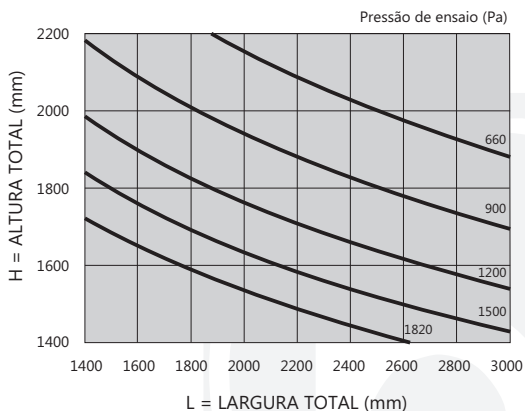
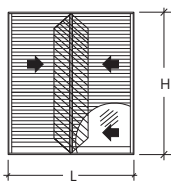

Montante Central

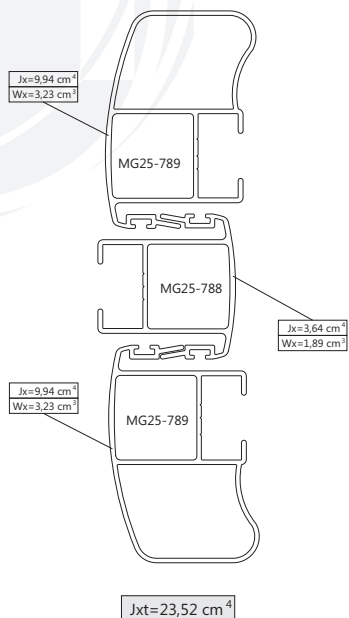
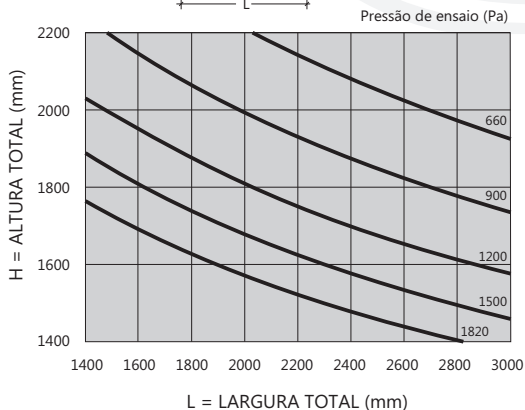
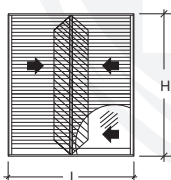

Montante Central

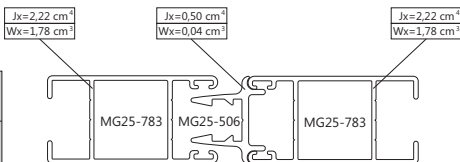
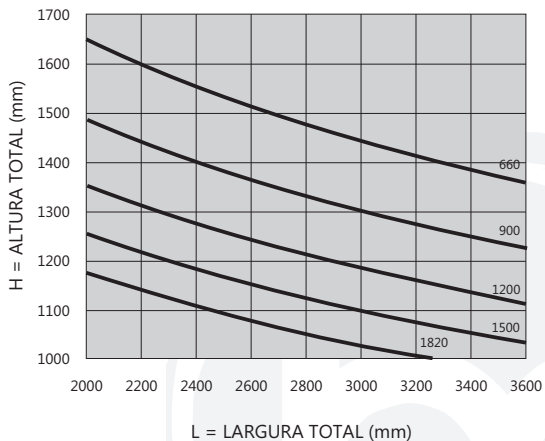
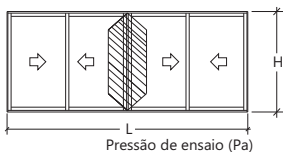

$J_{xt}=4,94 \text{ cm}^4$

Montante Central

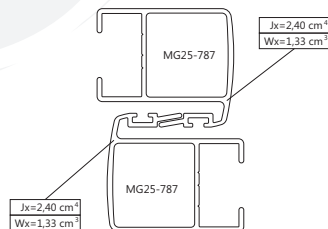
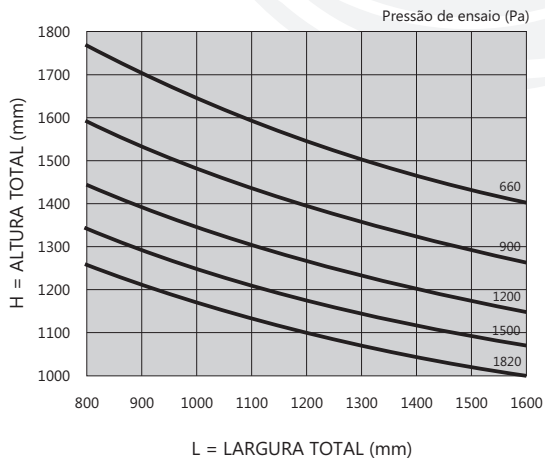
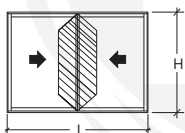

$J_{xt}=4,50 \text{ cm}^4$

Montante Central

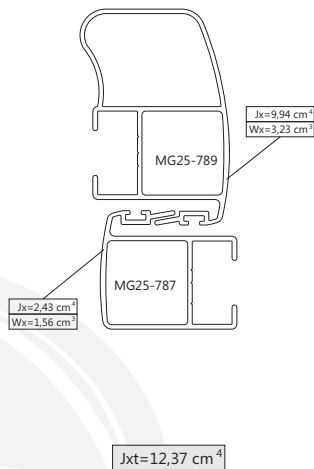
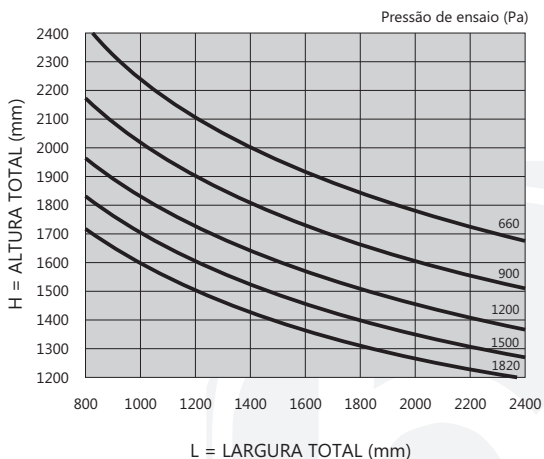
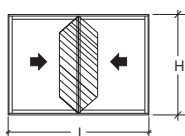

Montante Central

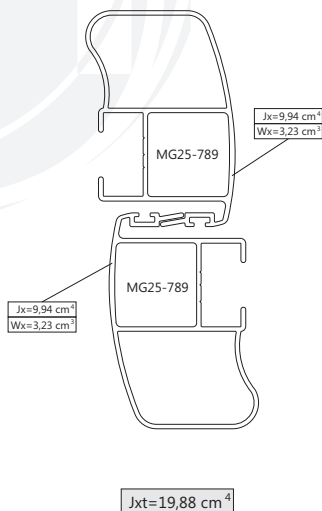
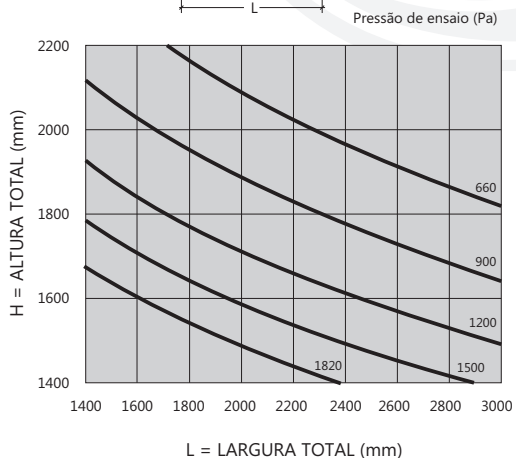
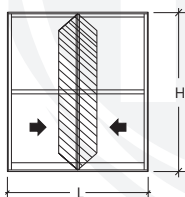



NORMAS

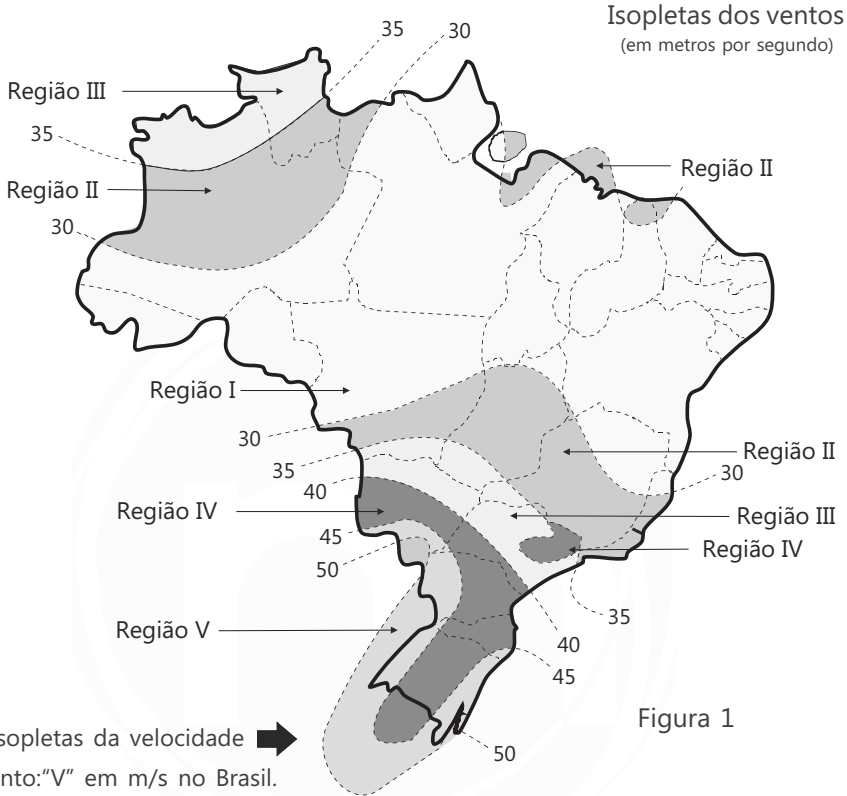

No Brasil, o comportamento estrutural de uma esquadria esta regulamentada pela NORMA NBR 10821.

Esta norma fixa as condições de desempenho de caixilhos em edificações residenciais e comerciais e visa assegurar ao consumidor, o recebimento de produtos com condições mínimas exigíveis de

desempenho, especificamente quanto à resistência a cargas uniformemente distribuídas e que apresenta um roteiro de cálculo da pressão de ensaio (vento e vedação).

ABNT NBR 10821 - Esquadrias externas para edificações

Tabela 1

Quantidade de pavimentos	Altura máxima	Região do País	Pressão de ensaio (Pa) Positiva e negativa $P_e = P_p \times 1,2$	Pressão de segurança (Pa) Positiva e negativa $P_s = P_e \times 1,5$	Pressão de água (Pa) $P_a = P_p \times 0,20$
02	6 m	I	350	520	60
		II	470	700	80
		III	610	920	100
		IV	770	1160	130
		V	950	1430	160
05	15 m	I	420	640	70
		II	580	860	100
		III	750	1130	130
		IV	950	1430	160
		V	1180	1760	200
10	30 m	I	500	750	80
		II	680	1030	110
		III	890	1340	150
		IV	1130	1700	190
		V	1400	2090	230
20	60 m	I	600	900	100
		II	815	1220	140
		III	1060	1600	180
		IV	1350	2020	220
		V	1660	2500	280
30	90 m	I	660	980	110
		II	890	1340	150
		III	1170	1750	200
		IV	1480	2210	250
		V	1820	2730	300



COMPLEXO INDUSTRIAL ASA ALUMÍNIO S.A.



A Asa Alumínio é uma empresa atuante, possui as instalações mais modernas do setor e está preparada para atender os mercados mais exigentes do mundo. Ocupando uma área com mais de 540 mil m², sendo 120 mil m² de área construída, a Asa Alumínio está dividida em duas Unidades.

O **Complexo Industrial 1**, unidade matriz onde estão instaladas as quatro prensas, **P-15, P-18, P-20 e P-35**.

E, o novíssimo complexo 2, com as duas prensas, **P-21 e P-40**. A proposta foi construir a nova fábrica, mantendo a integração com a planta existente. Juntas somam uma capacidade para 70 mil toneladas de perfis por ano.

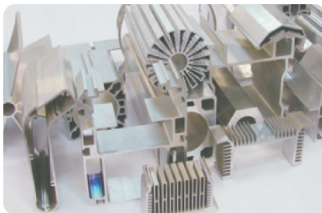

PRONTA -ENTREGA

Um estoque com mais de **Mil Toneladas de Perfis**, com os itens de maior giro, especialmente as Linhas e Sistemas para Esquadrias.



AMPLA CAPACIDADE TÉCNICA

Pleno domínio da tecnologia de desenvolvimento e produção de perfis com características de performance diferenciada como: Grandes dimensões, alta precisão dimensional e peças que requerem ligas e têmperas especiais. Total segurança para propor inovações e uma melhor relação de custo-benefício.



Qualidade que resiste ao tempo!

DISTRIBUIDOR CREDENCIADO ASA ALUMÍNIO:

vendas@asaaluminio.com.br
comercial@asaaluminio.com.br



Rua da Cerâmica, 100 Bairro São João
CEP 13051-156 Campinas - SP

TEL 19 3227-1000
FAX 19 3228-1000



www.asaaluminio.com.br